

АТЛАСЪ ЧЕРТЕЖЕЙ

ВЪ

РУКОВОДСТВУ

ПО

**КОРАБЛЕСТРОЕНІЮ**

А. РОЗЕ. (A. HAUSER).

ТОМЪ I

ЧАСТЬ ПЕРВАЯ.

ПОСТРОЙКА СУДОВЪ ИЗЪ ЖЕЛѢЗА И СТАЛИ.

---

С.-ПЕТЕРБУРГЪ.

Типографія Морского Министерства, въ Главномъ Адмиралтействѣ.

1890.

Фиг. 89.

Фиг. 93.

Фиг. 94.

Terrible.

Диаметральная плоскость судна.

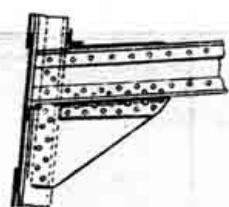
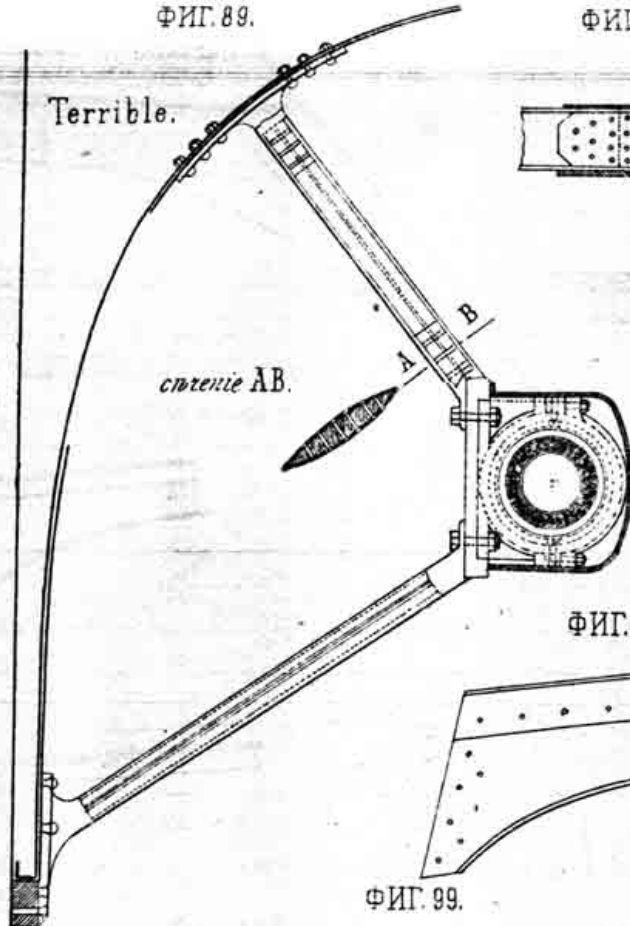

Фиг. 95.

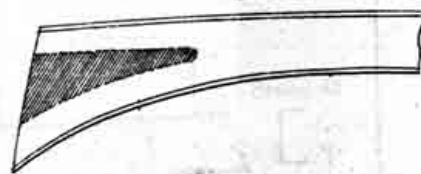

Фиг. 97.

Фиг. 96.

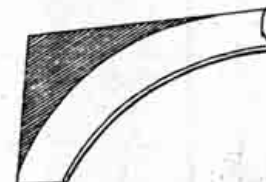
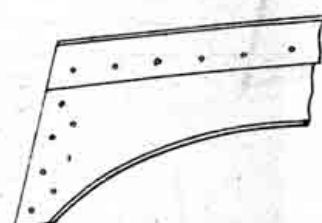

Фиг. 99.

Фиг. 100.

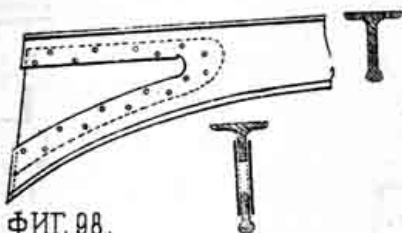

Фиг. 98.

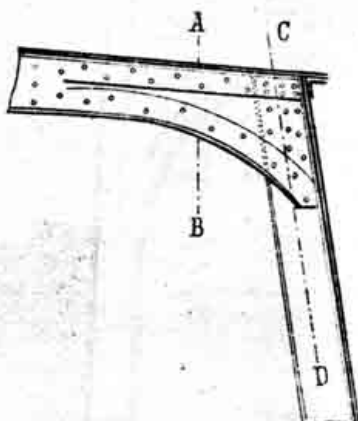

стение АВ

стение CD.

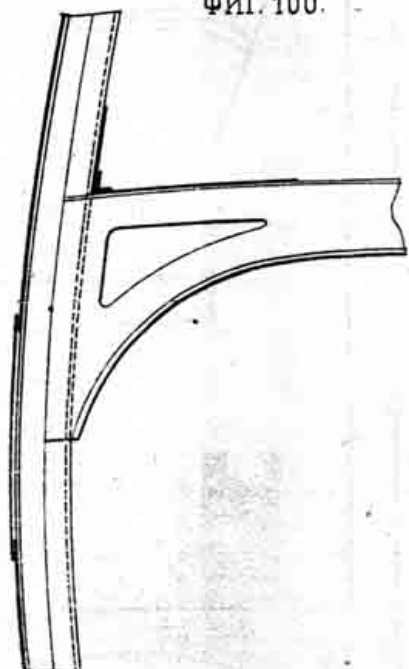

Фиг. 135.

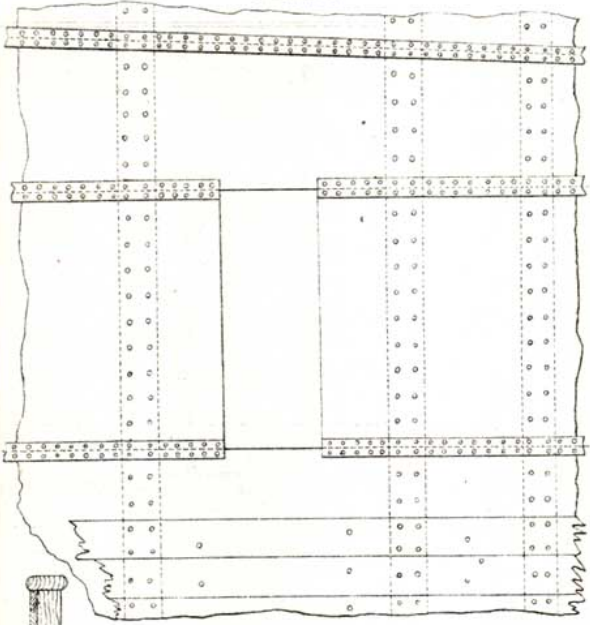

Фиг. 137.

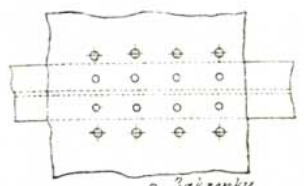

○ Зайденки  
 ⊕ Крепление Деревянной  
 обшивки

Фиг. 138.

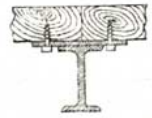

Фиг. 139.

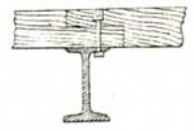

Фиг. 143.

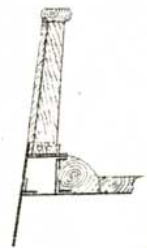

Фиг. 142.

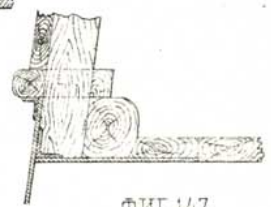

Фиг. 140.



Фиг. 141.

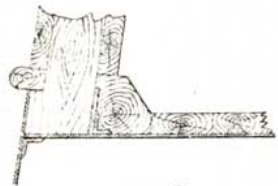

Фиг. 146.

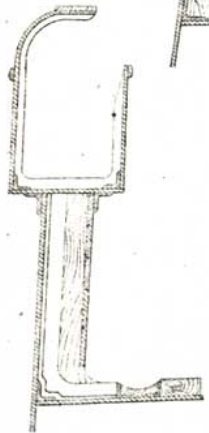

Фиг. 147.

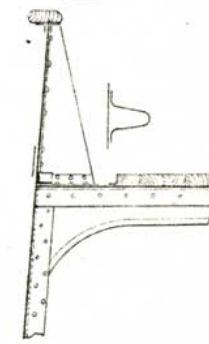

Фиг. 144.  
Hercules.

Фиг. 145.

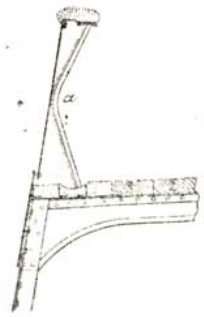

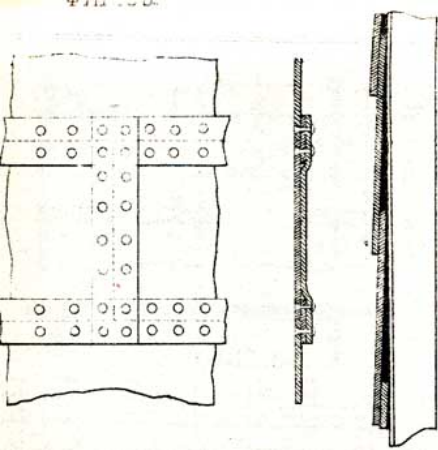

ФИГ. 160.

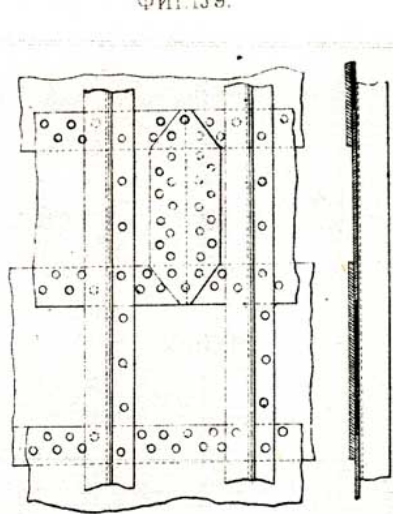

ФИГ. 158

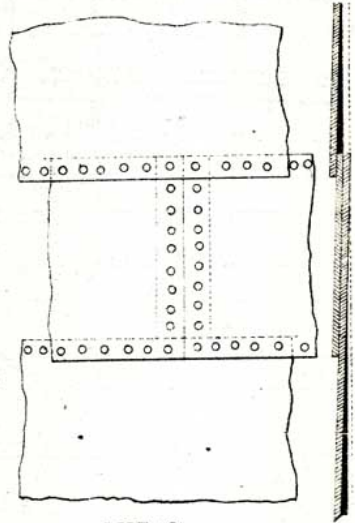
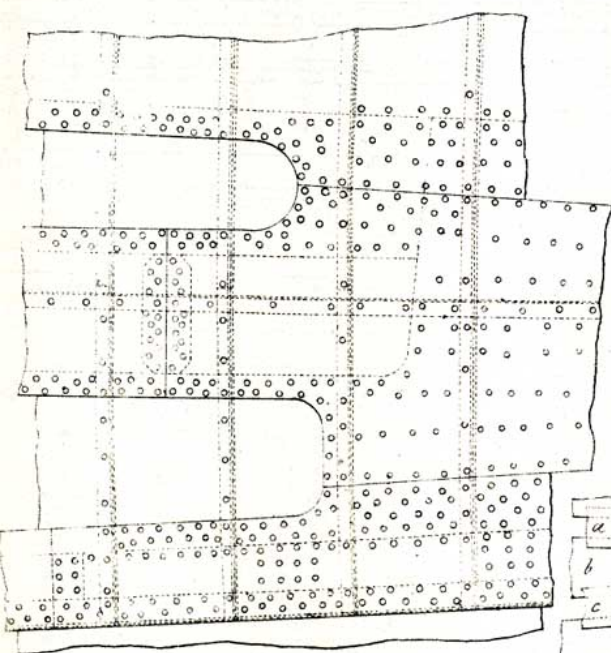

ФИГ. 161.



горизонтальное сечение

Фиг. 210.  
Tonnerre.

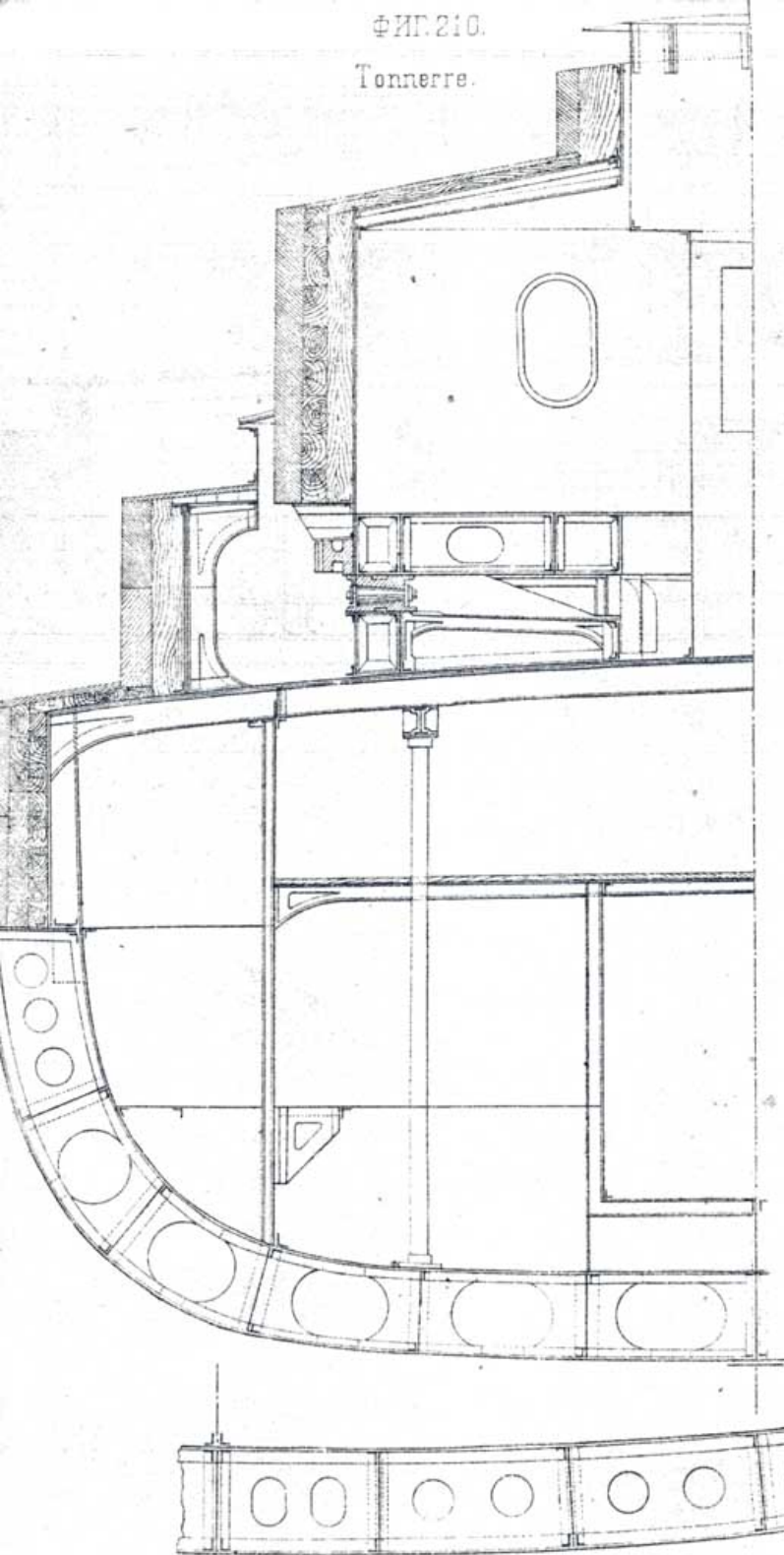

Фиг. 209.  
Devastation.

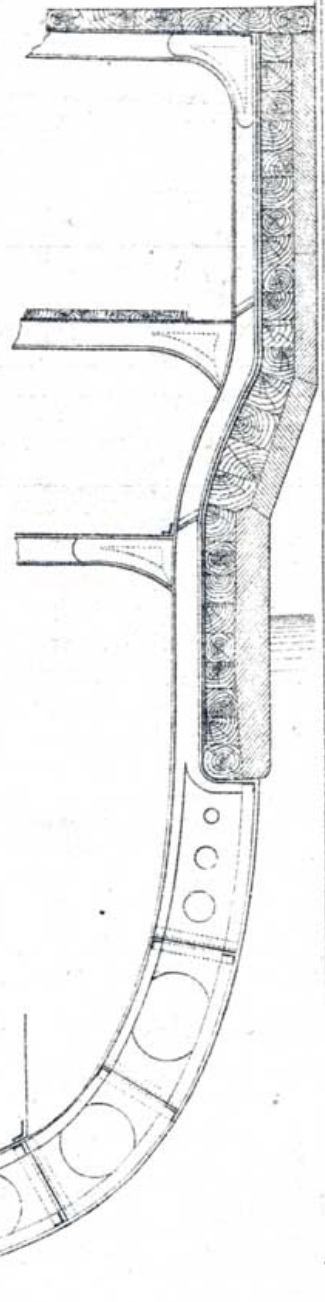



ФИГ 99

Треножникъ въ С. Назерь.

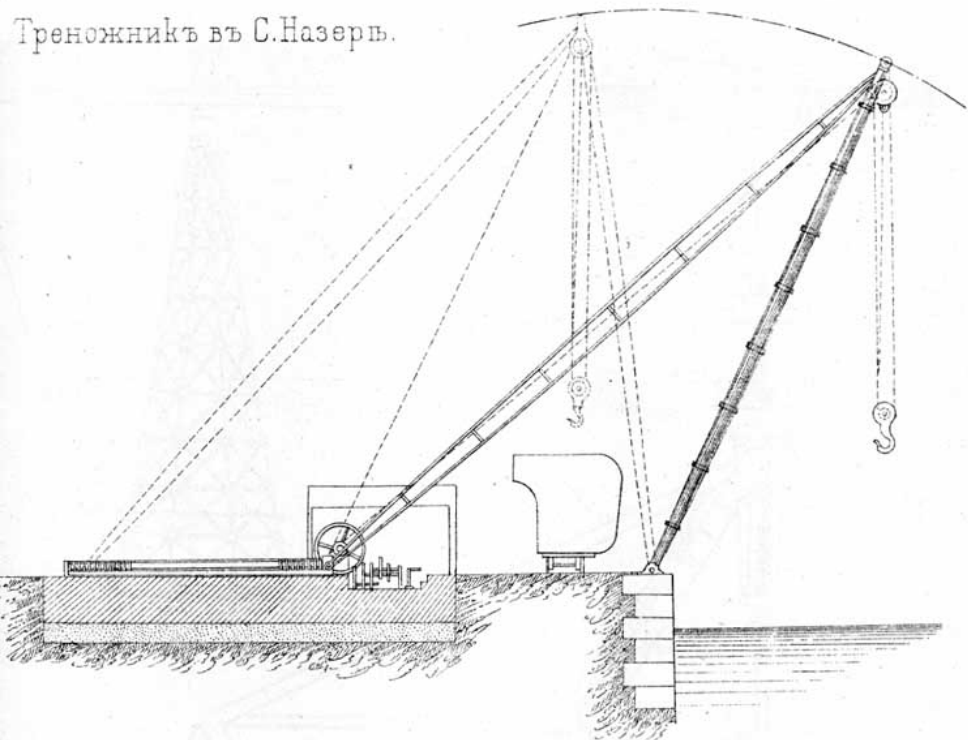

ФИГ 100

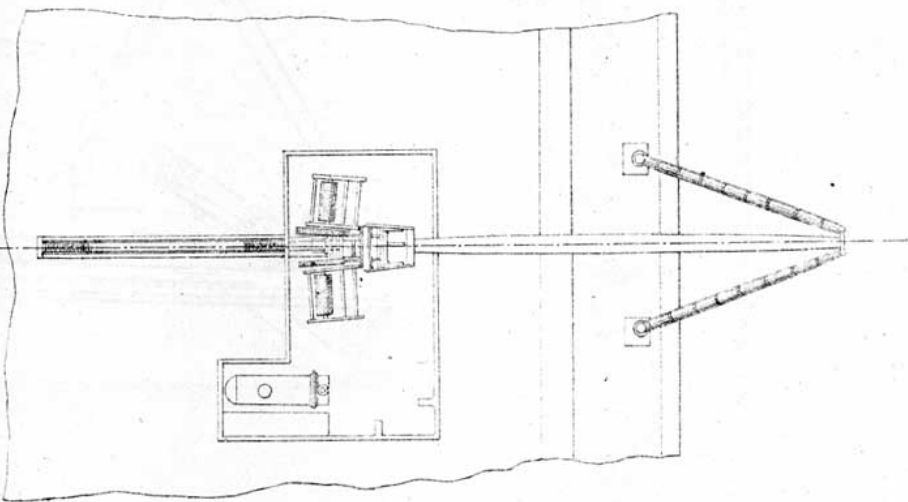

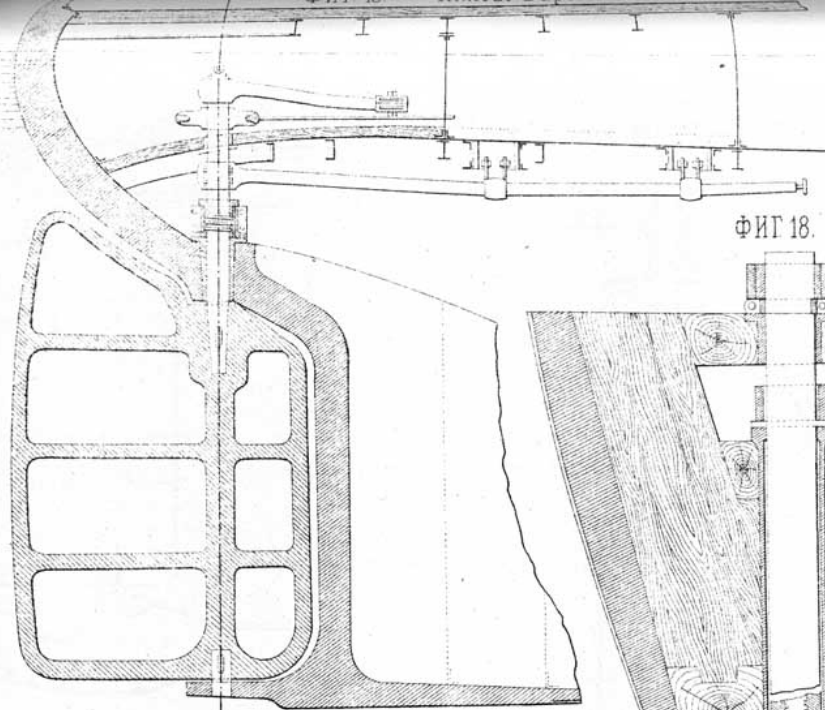

Фиг 18.

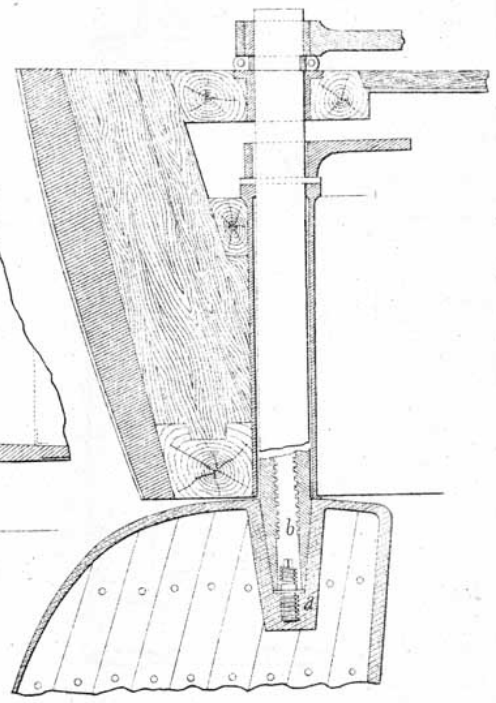

Фиг 15.

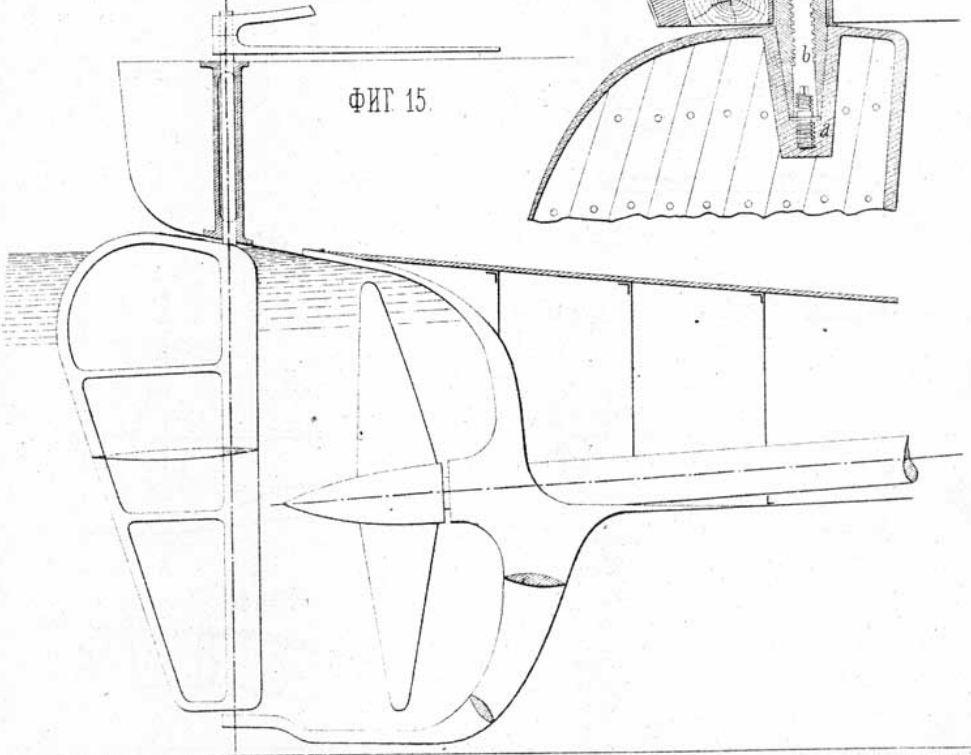

Ф И Г. 41.

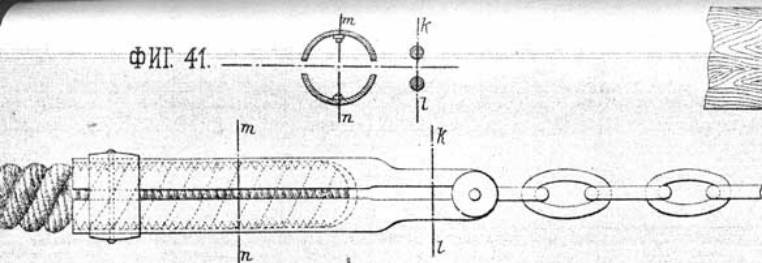

Ф И Г. 43.

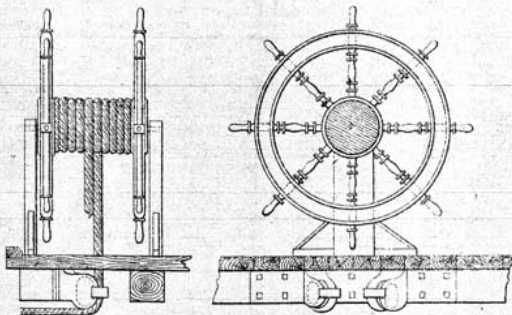

Ф И Г. 44.

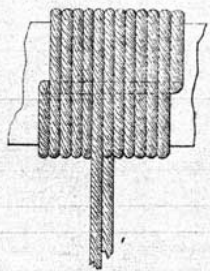

Ф И Г. 45.

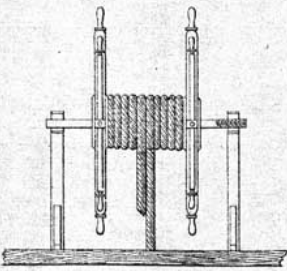

Ф И Г. 46.

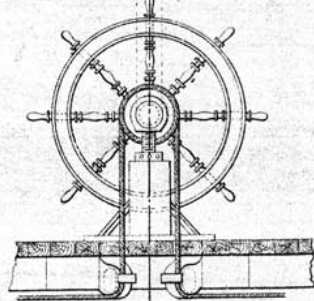
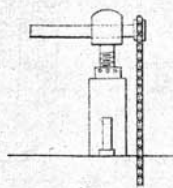
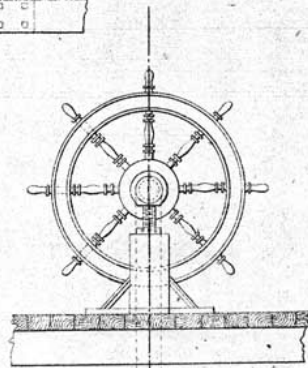



ФИГ. 71.

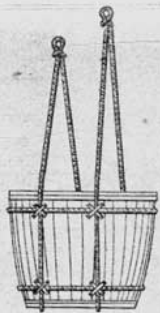

ФИГ. 66.  
Amiral-Duperré.

Верхняя палуба

Батарея

Нижняя палуба

Проходь.

Запасы 3/4 с. м  
орудий

Задняя ко-тегар-  
ня.

Передняя ко-тегар-  
ня.

ФИГ. 64.

Стение CD.

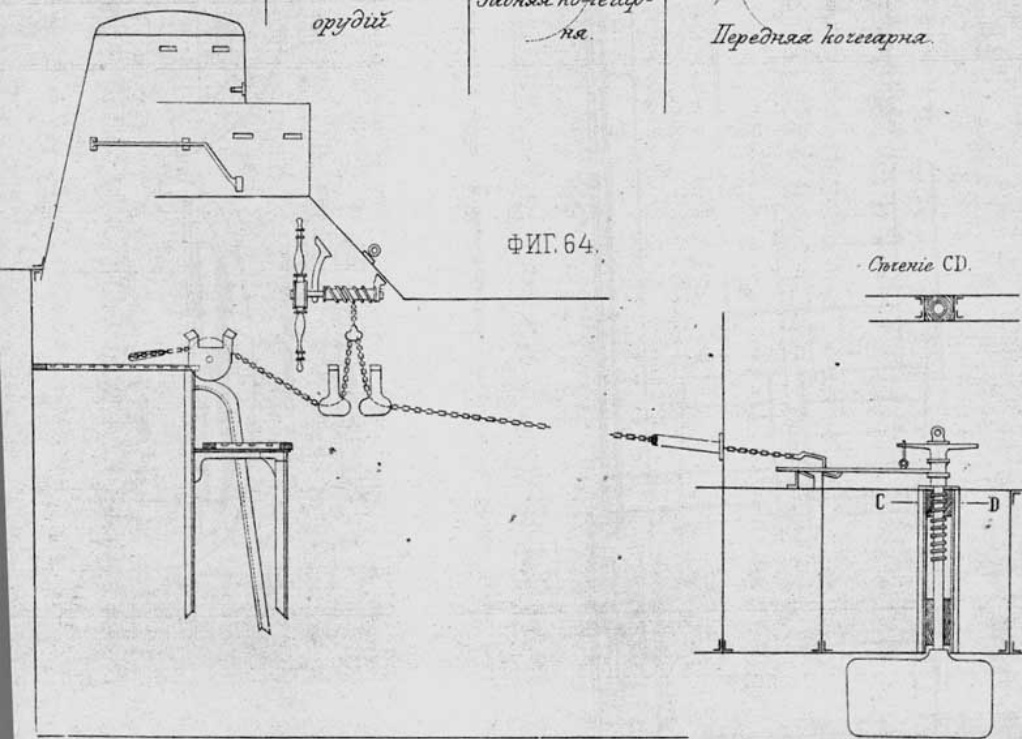

Фиг. 73.

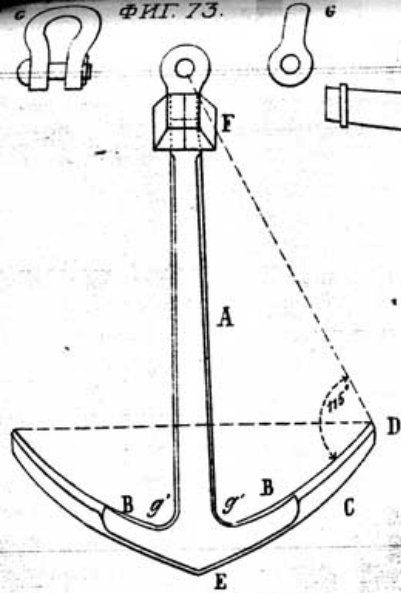

Фиг. 76.

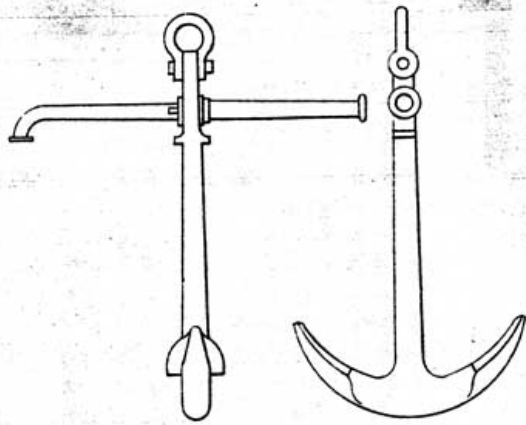

Фиг. 78.

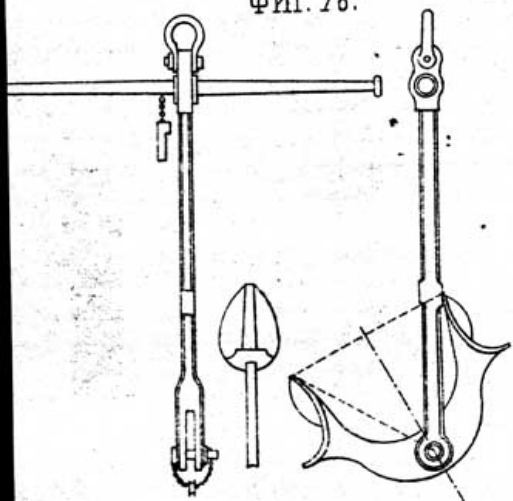

Фиг. 74.

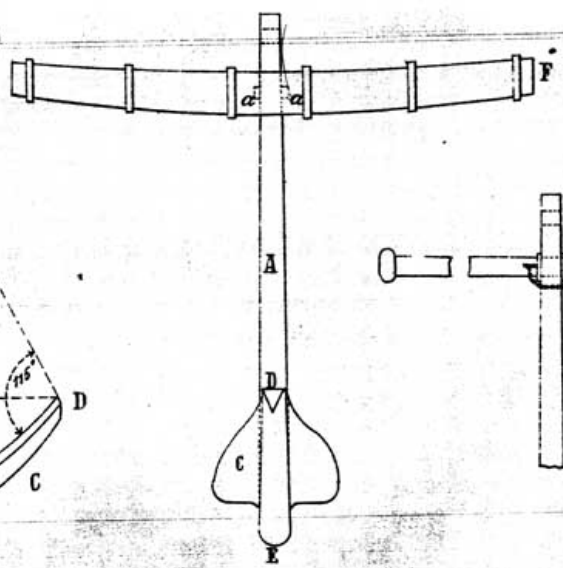

Фиг. 75.

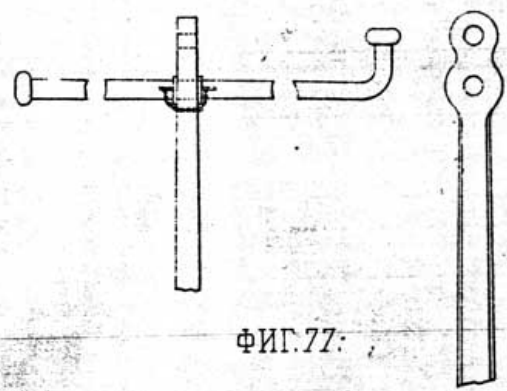

Фиг. 77.

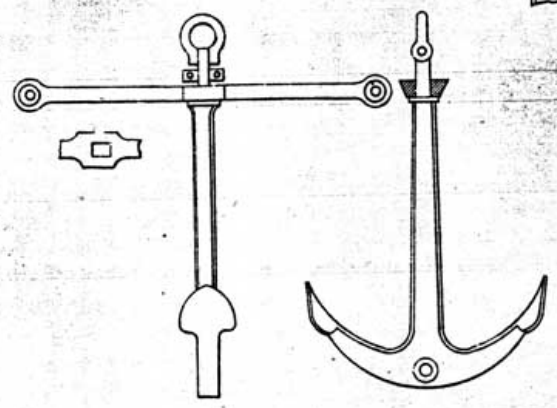

Фиг. 79.

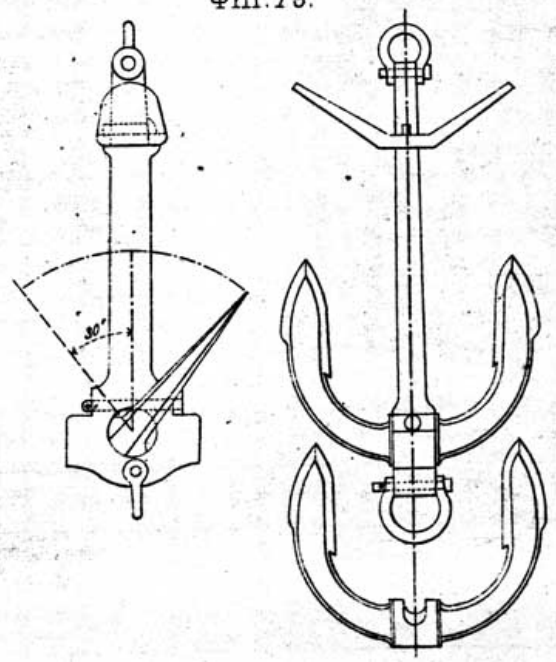

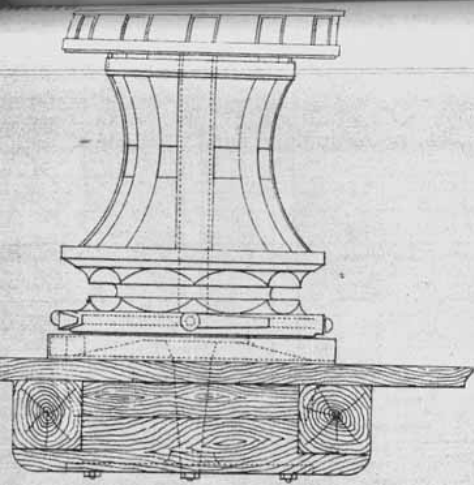

ФИГ. 117.

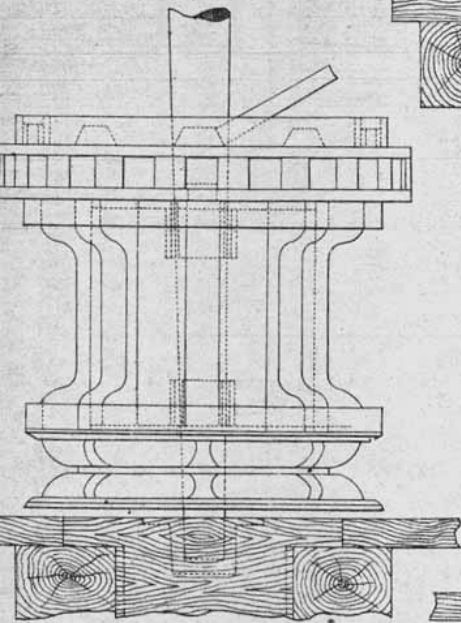

ФИГ. 113.



ФИГ. 115.

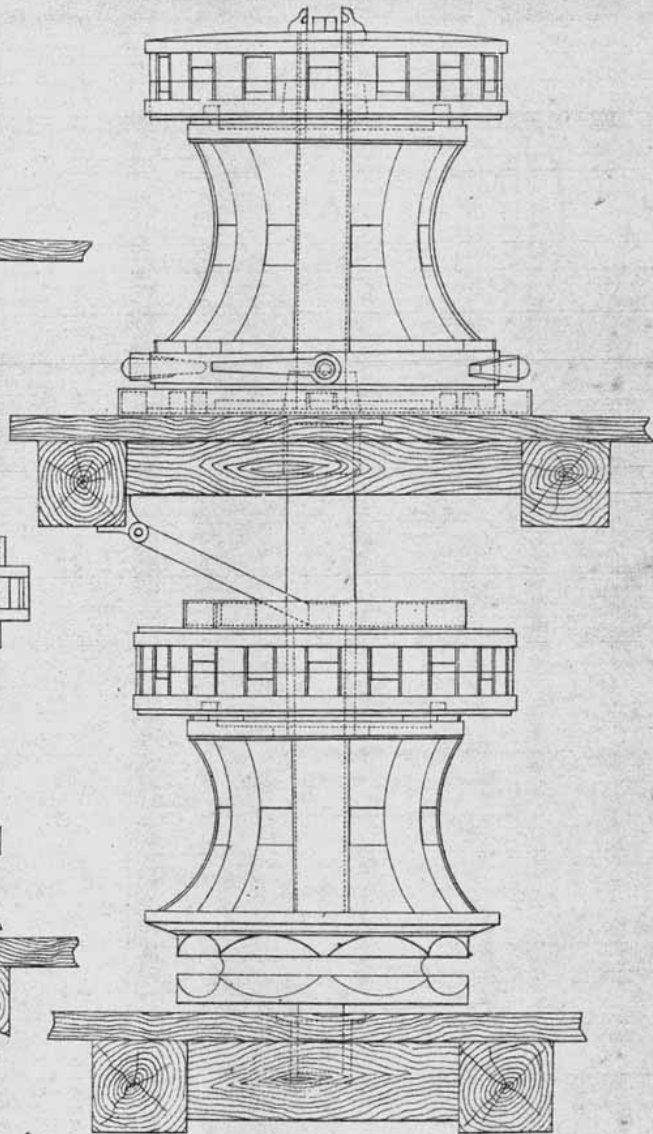

ФИГ. 114

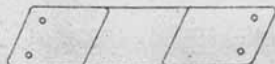
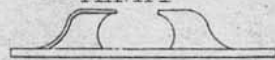

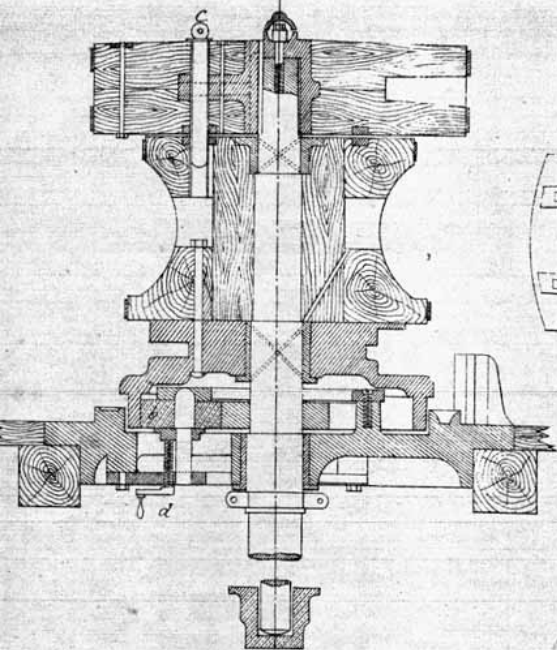

ФИГ. 121.

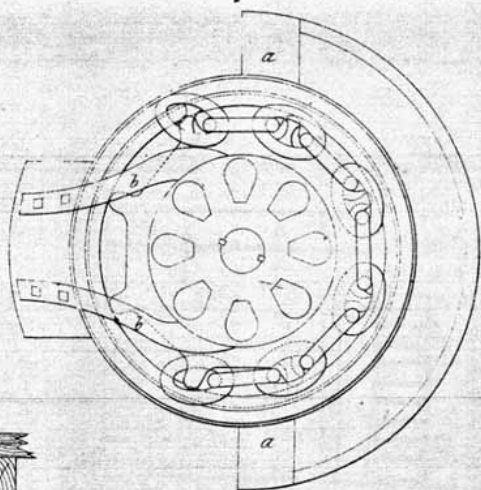
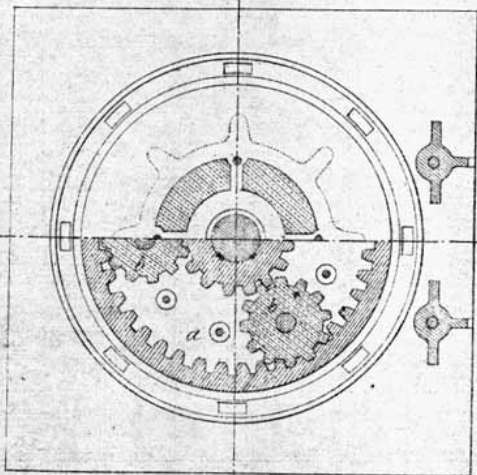

ФИГ. 119.

*Вертикальный вид*

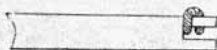

*Горизонтальная проекция*

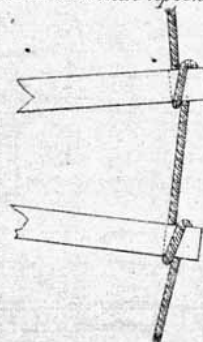

ФИГ. 126.

Ниве.

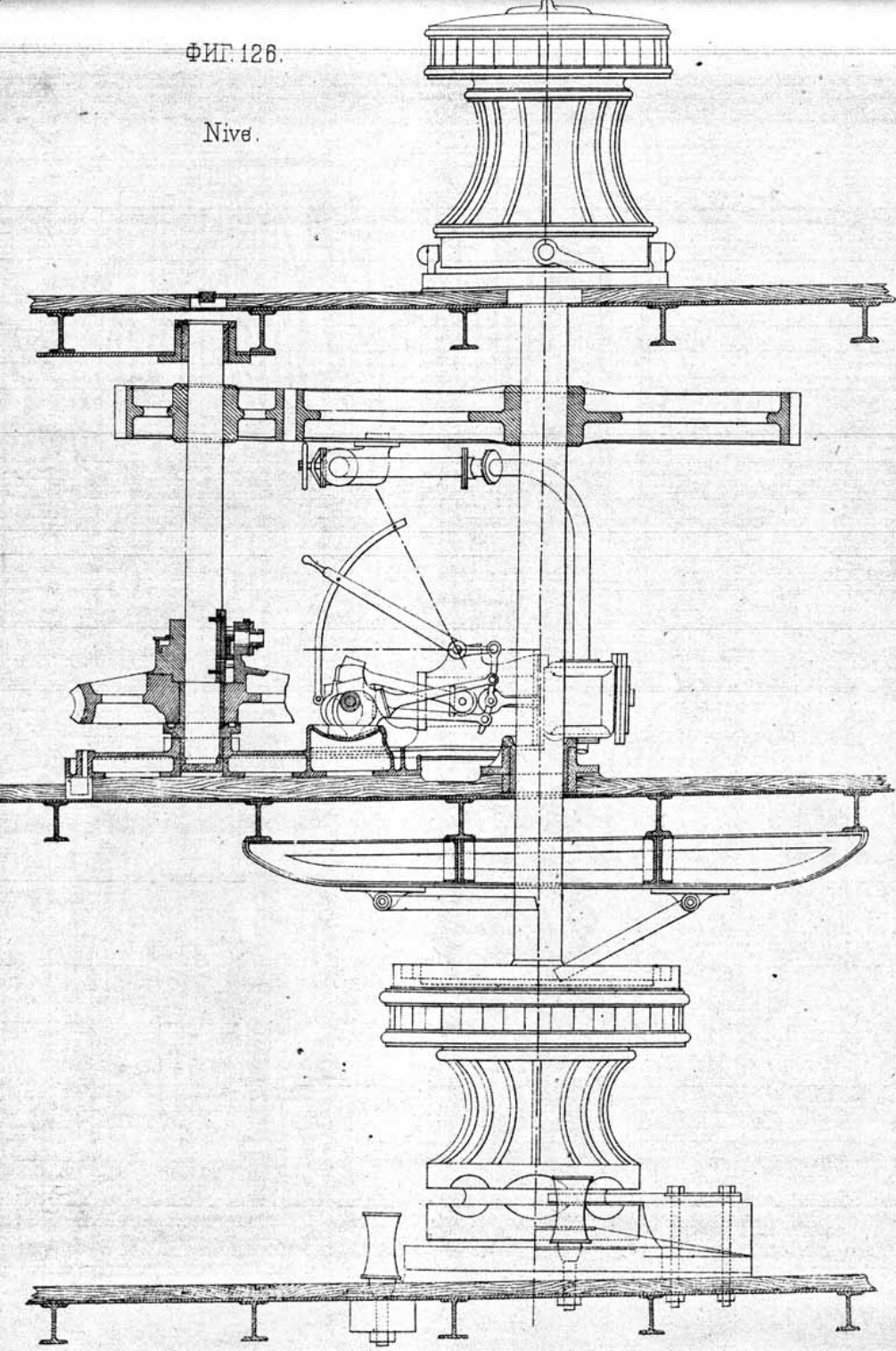



Фиг. 150.

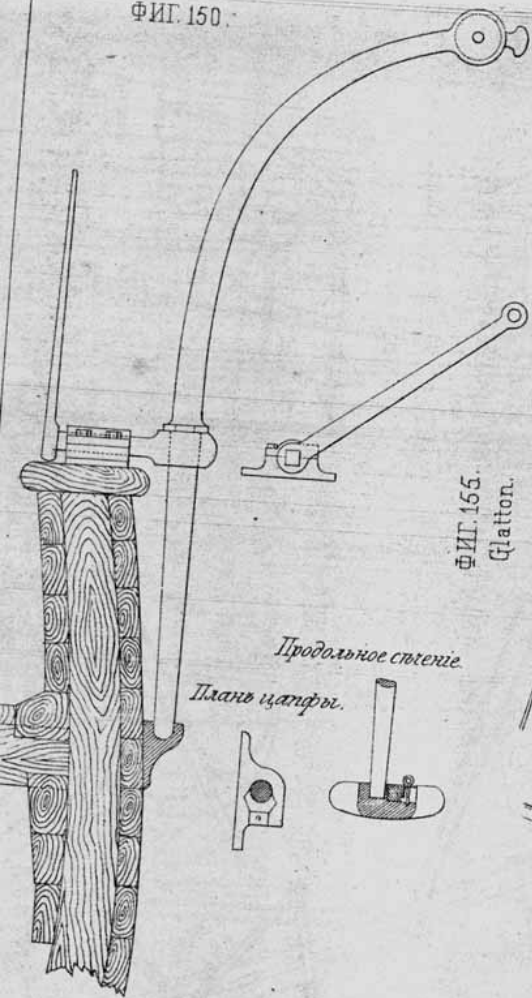

Фиг. 155.  
Glatton.

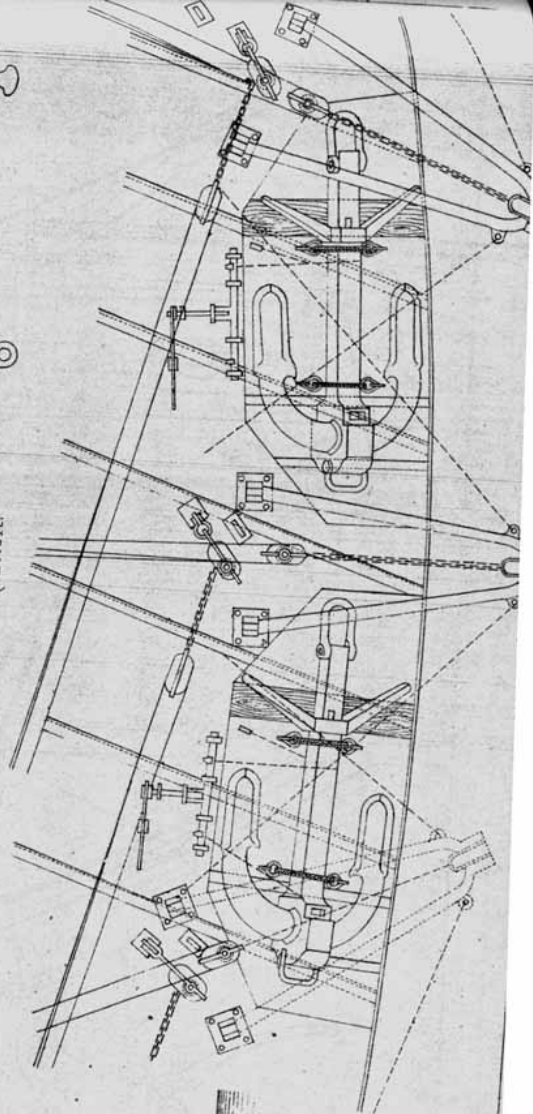

Фиг. 154.

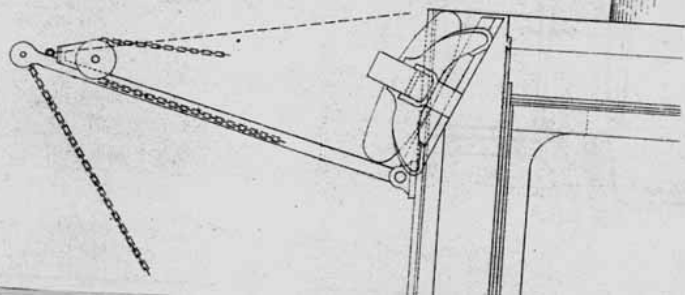



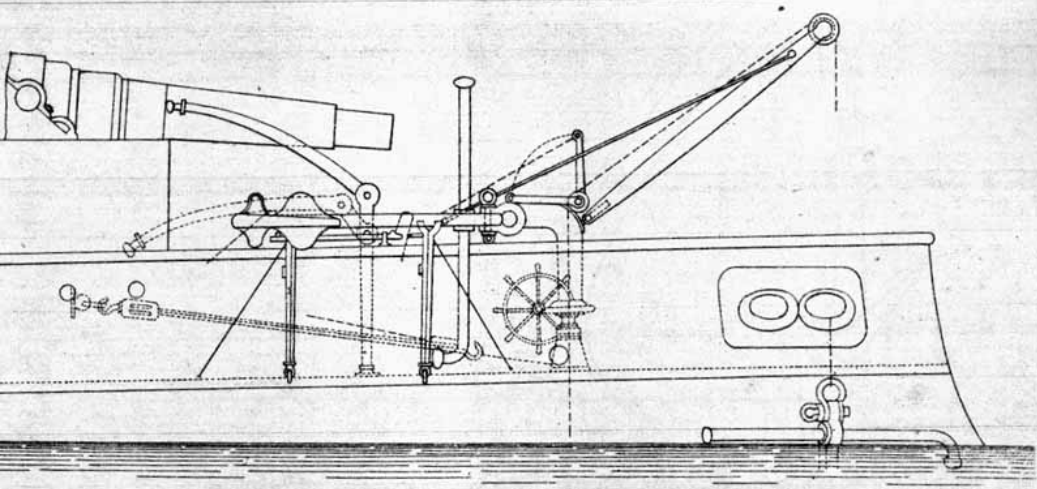

ФИГ. 152.

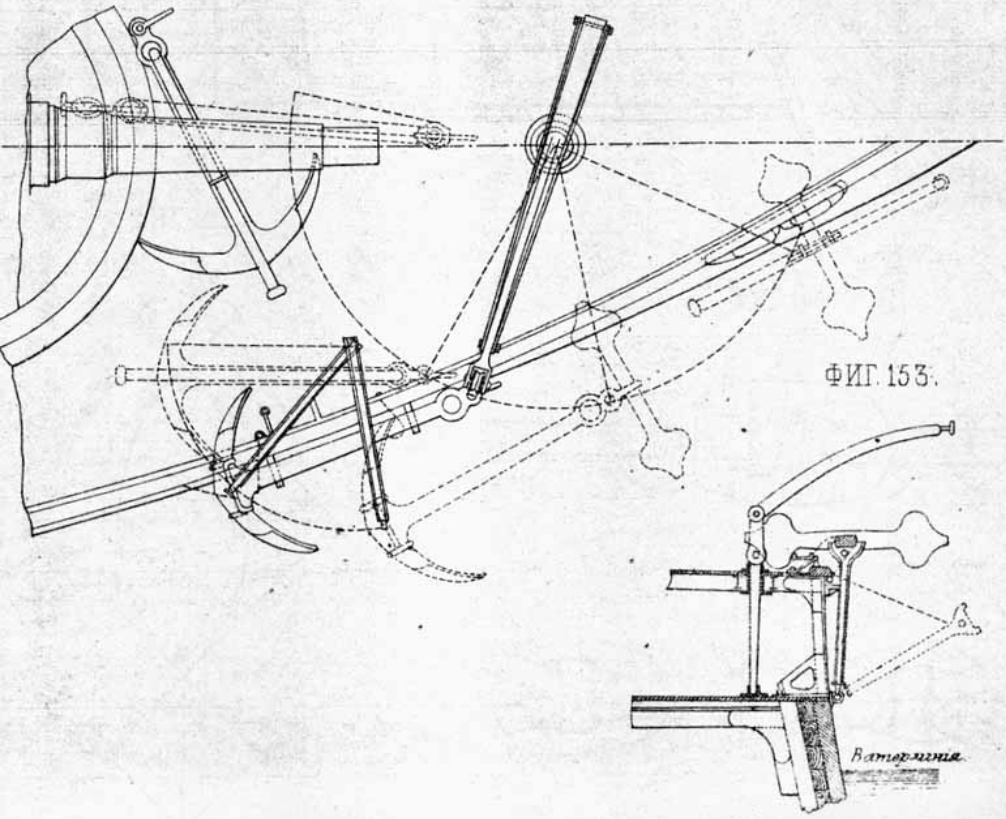

ФИГ. 153.

Ватерлиня.

Καράβι 12 μ. (33')

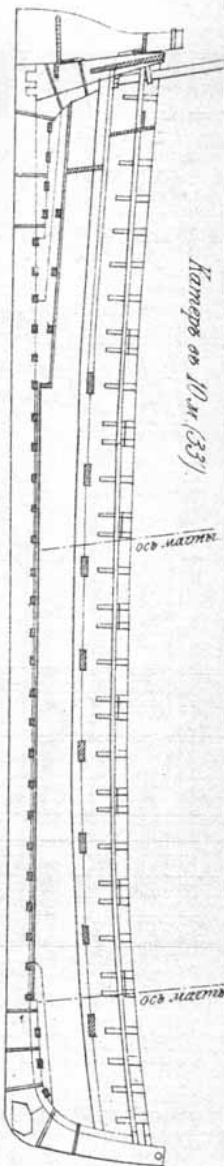

ΦΙΓ. 163.

Παρωπιό καράβι 10 μ. (33')

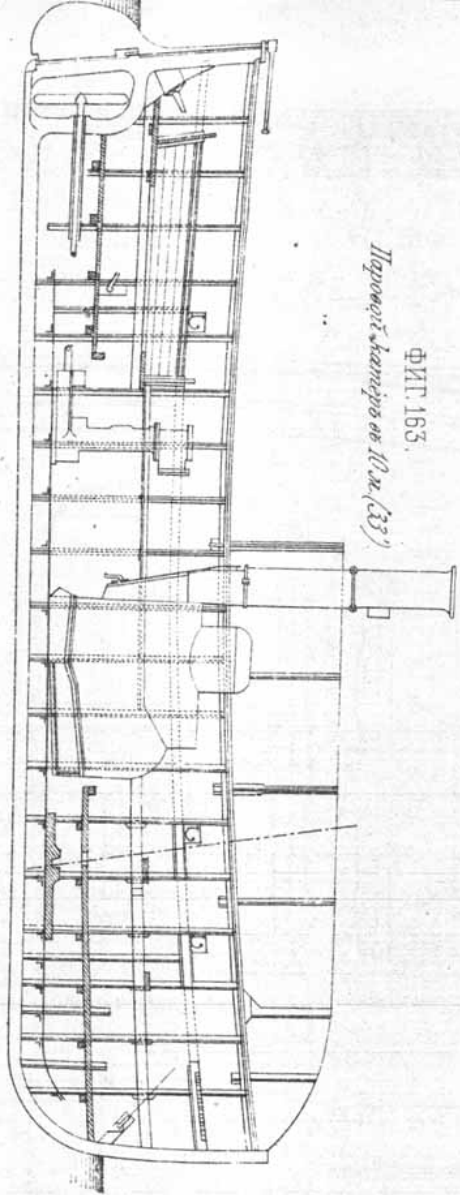

ΦΙΓ. 164.

Καράβι Υαδύνα 6,00 μ. (21 1/2')

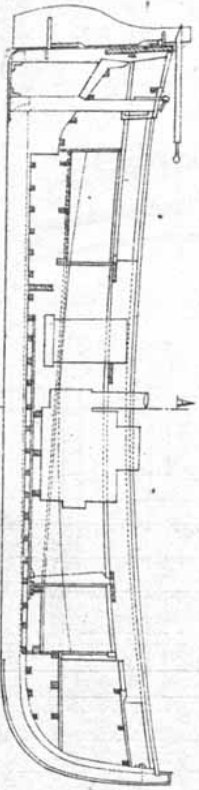

Χαροπιό ΑΒ.

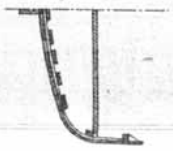
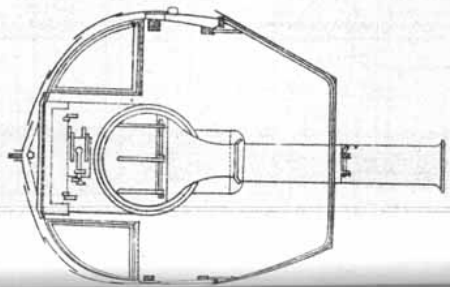
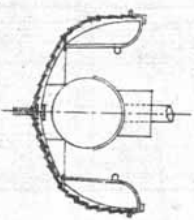

Фиг. 191.

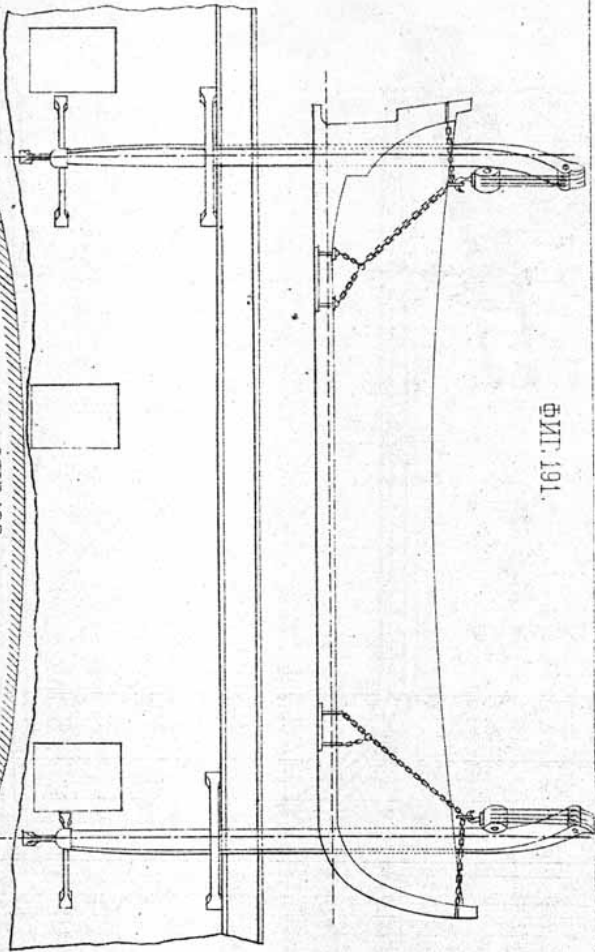

Фиг. 192.

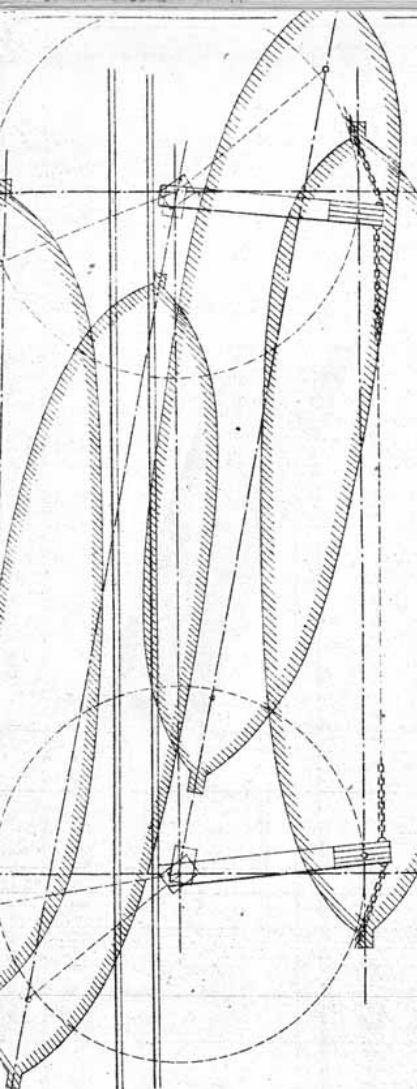

Фиг. 193.

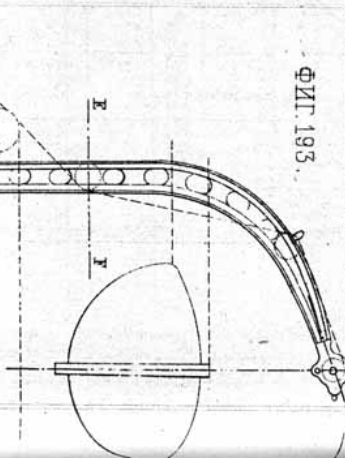

Чертеж П.

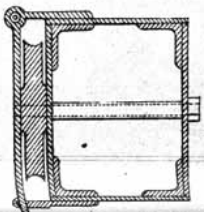

Фиг. 195.

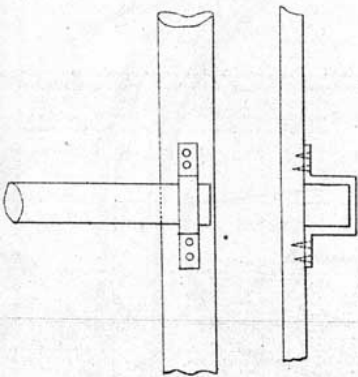

Фиг. 194.

Seignelay.

Соедине А В.

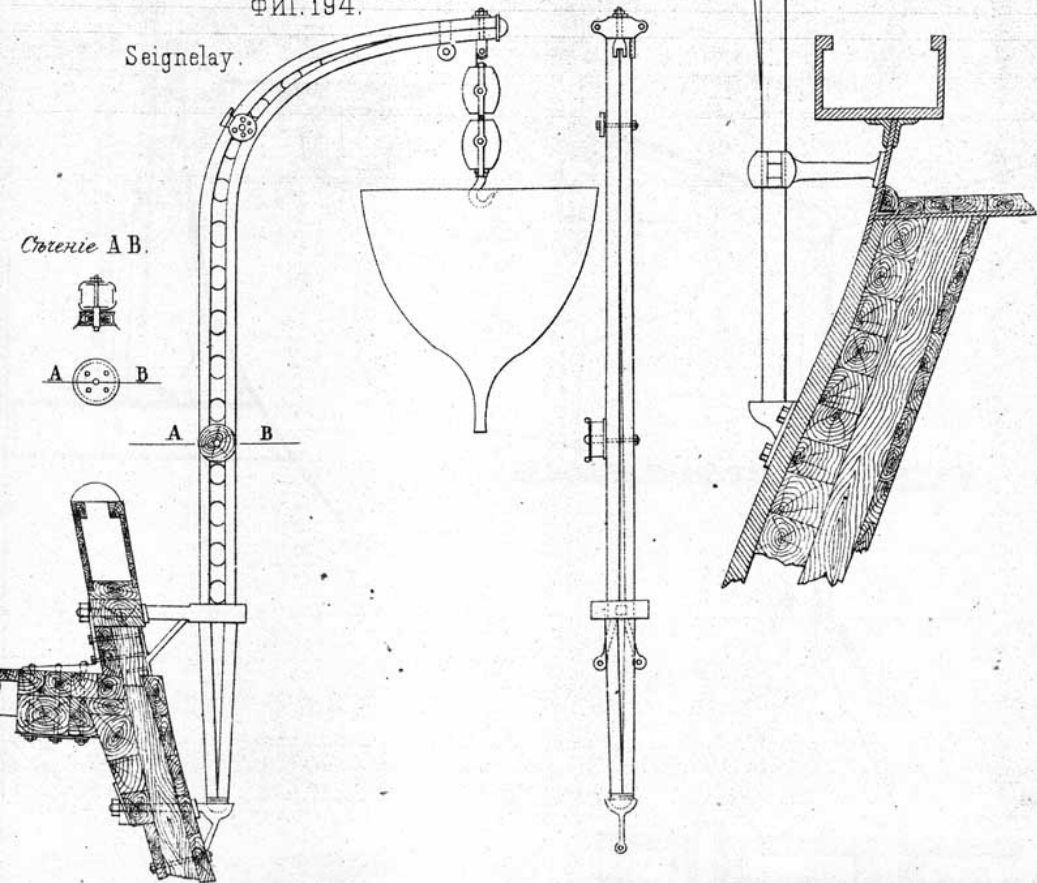

Фиг. 202.

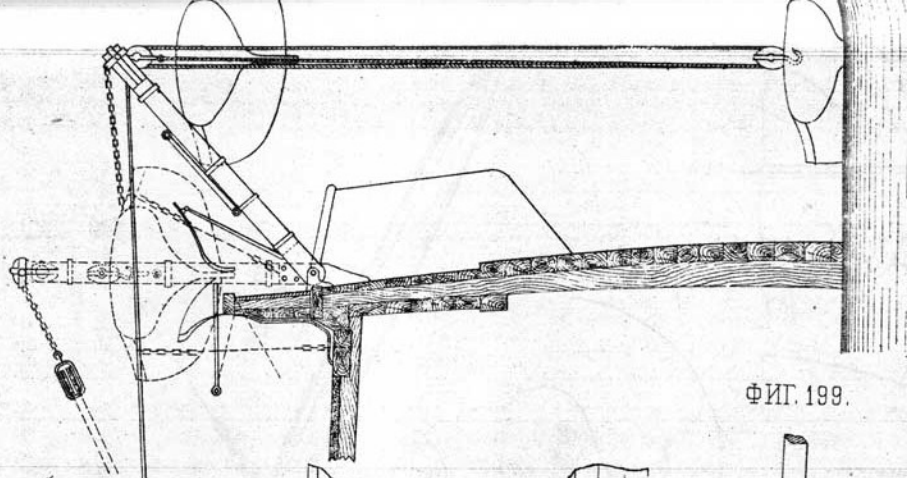

Фиг. 199.

garonne.

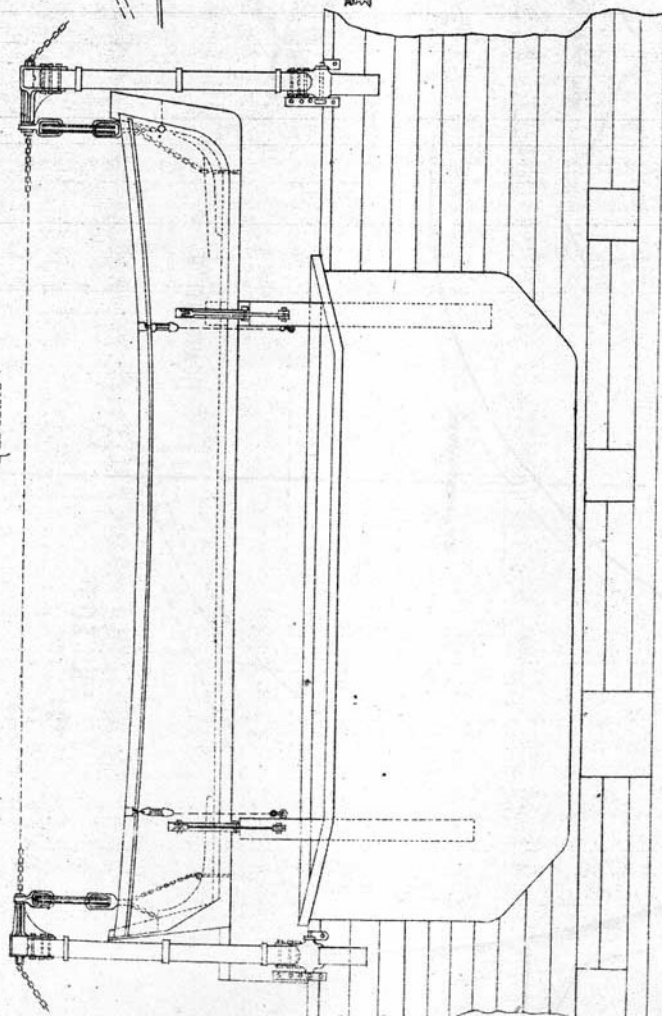

Фиг. 200.



Фиг. 198.

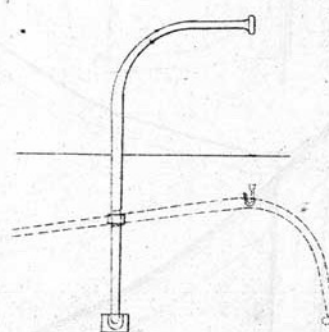

ФИГ. 204.

Толщере.

Пристробленіе для подемъ  
шляпке

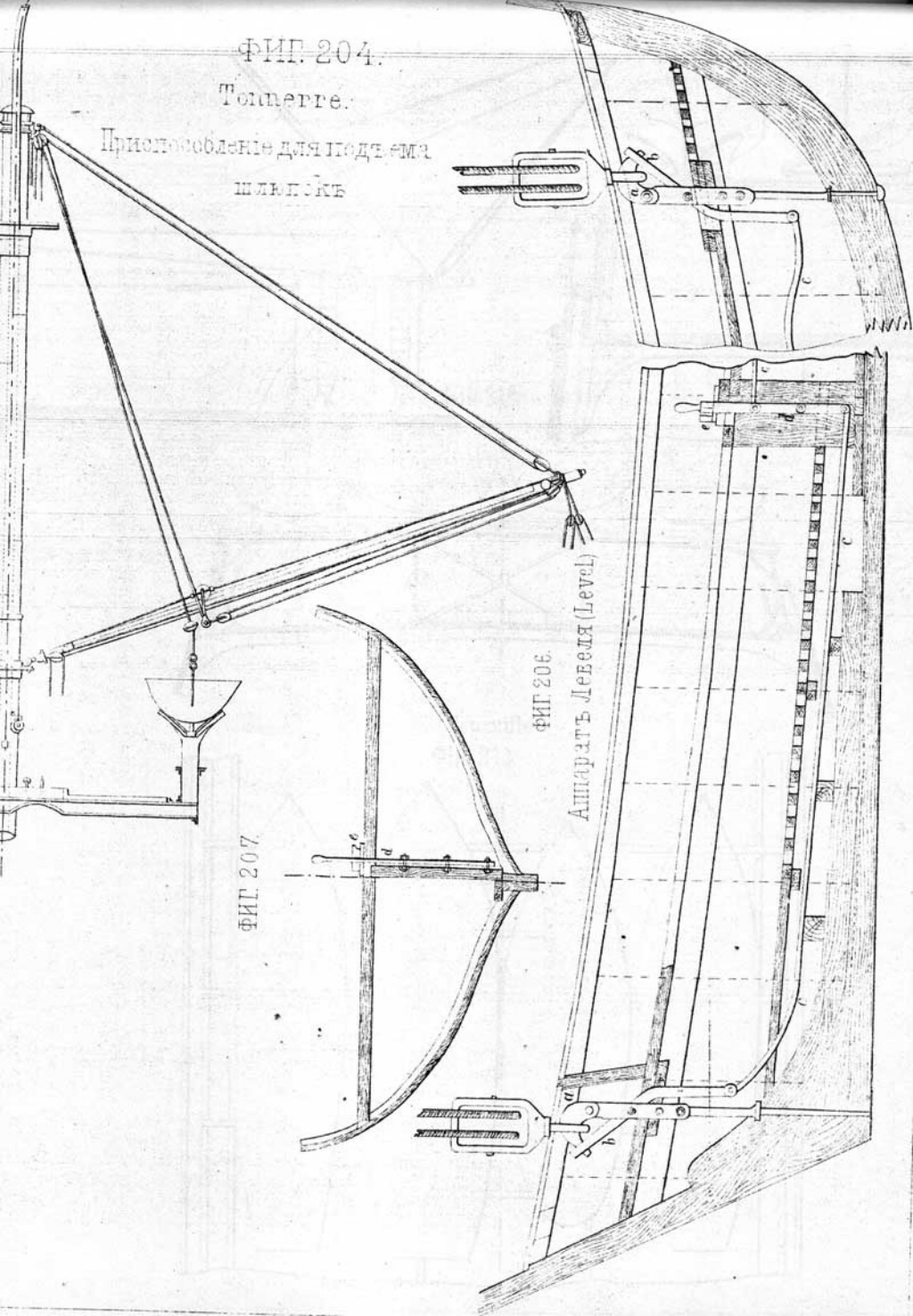

ФИГ. 207.

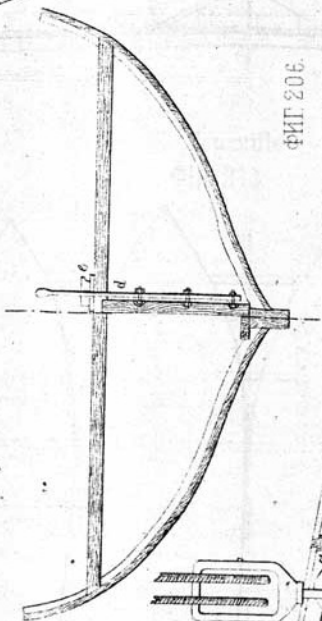

ФИГ. 206.

Аппаратъ Ловедя (Level)

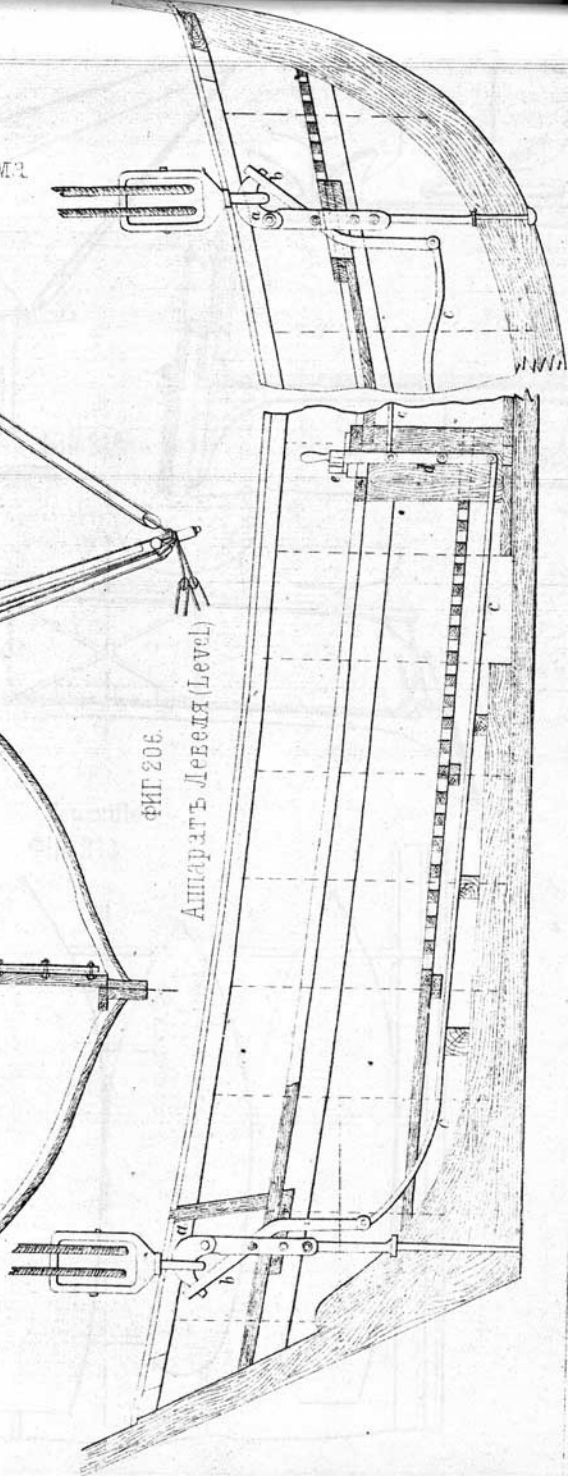



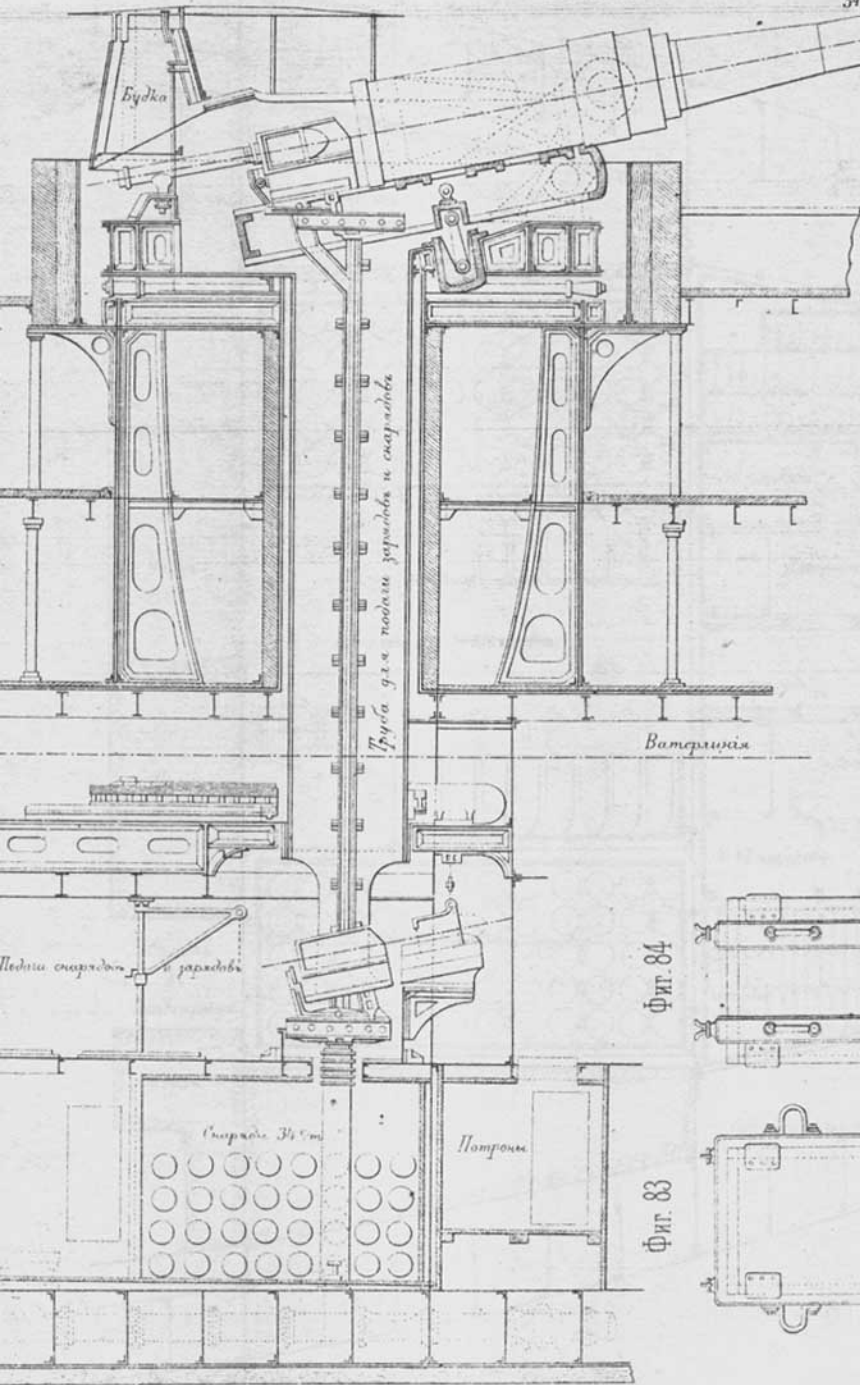

Фиг. 84

Фиг. 83

Фиг. 139

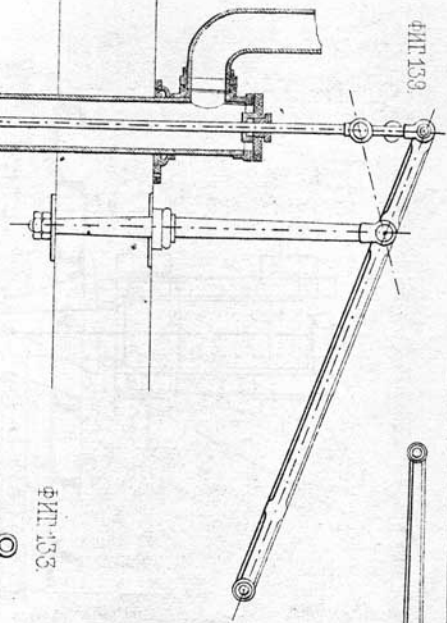

Фиг. 133

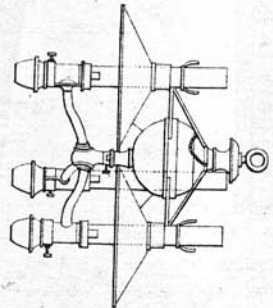

Фиг. 138

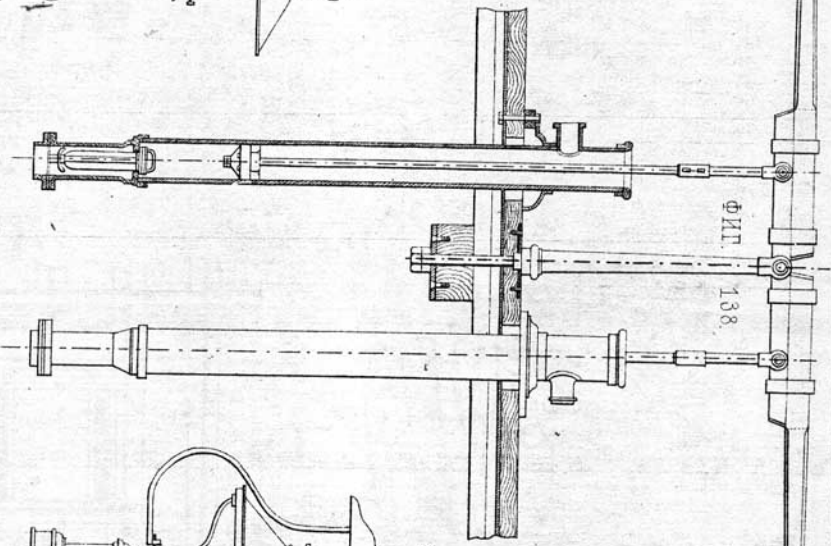

Фиг. 135

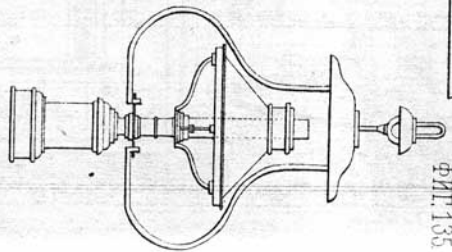

Фиг. 140

Amiral Baurain

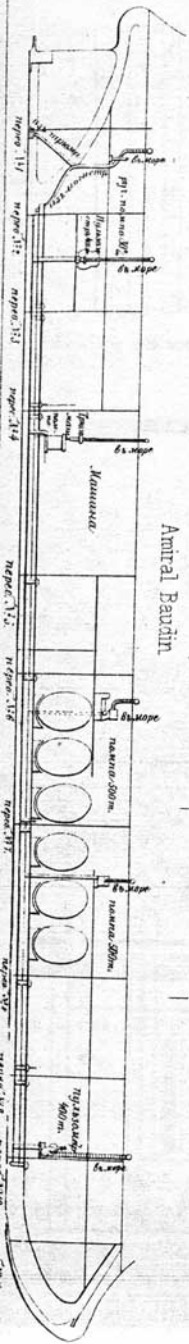

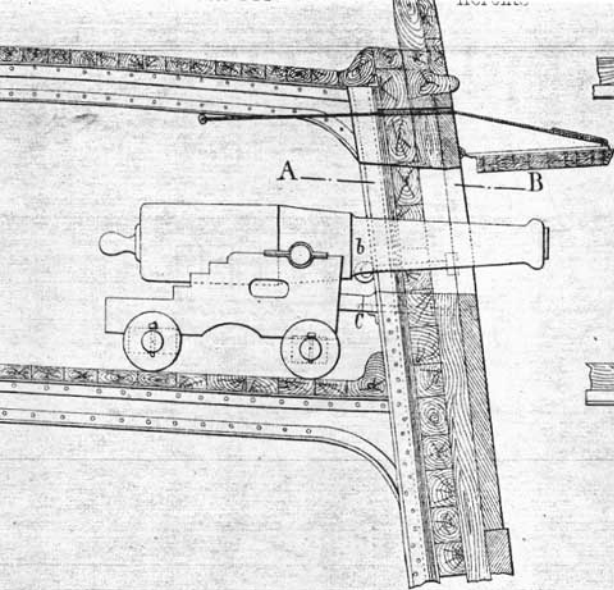

ФИГ 143.

Съченіе АВ.

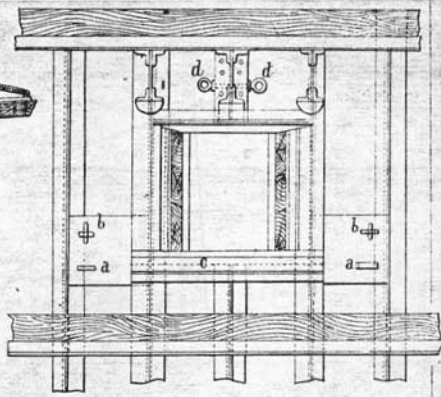
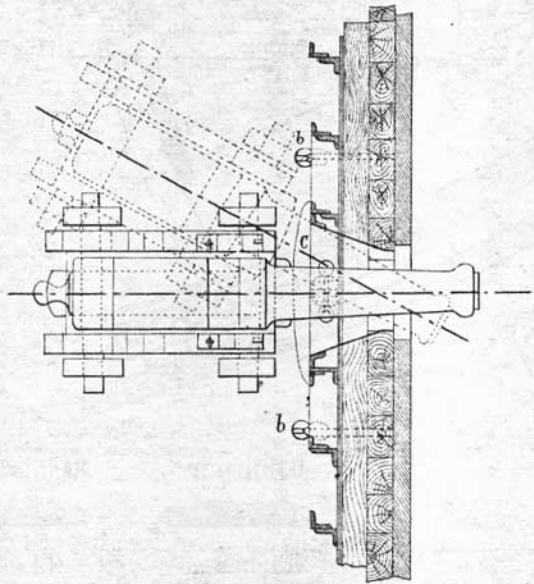

ФИГ 146.

Suffren.

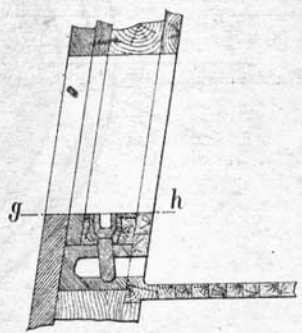

Съченіе gh

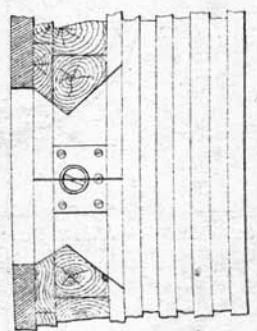

ФИГ. 144.  
Tourville.

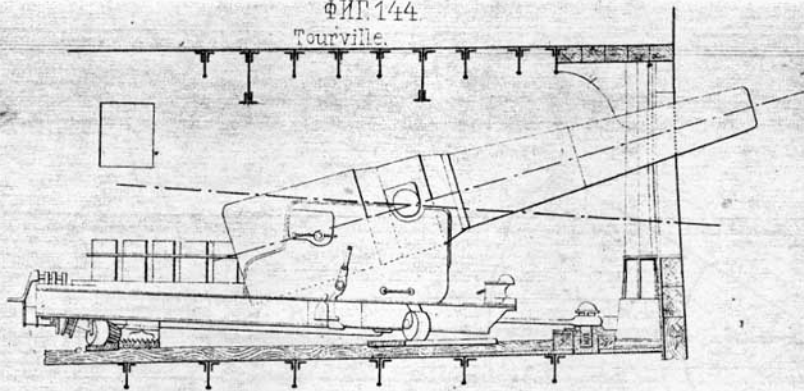

ФИГ. 145.

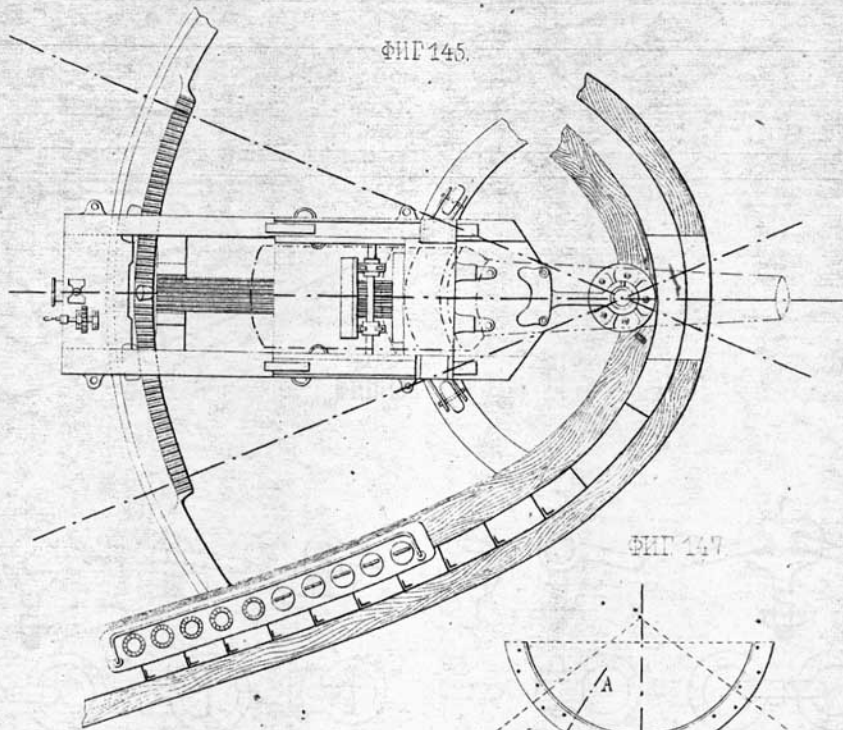

ФИГ. 147.

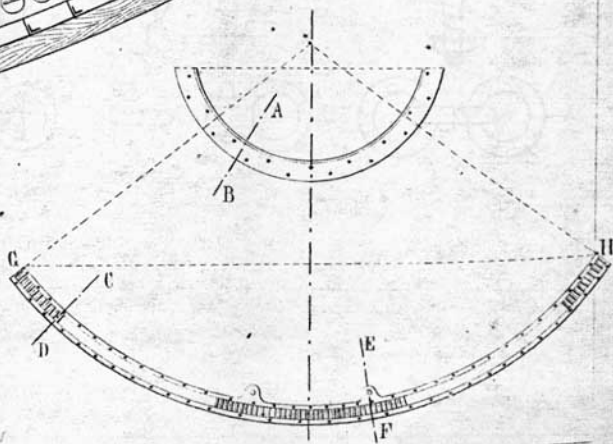

Спиченіе АВ.



Спиченіе СД.



Спиченіе ЕФ.



Спиченіе ГН.

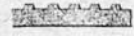

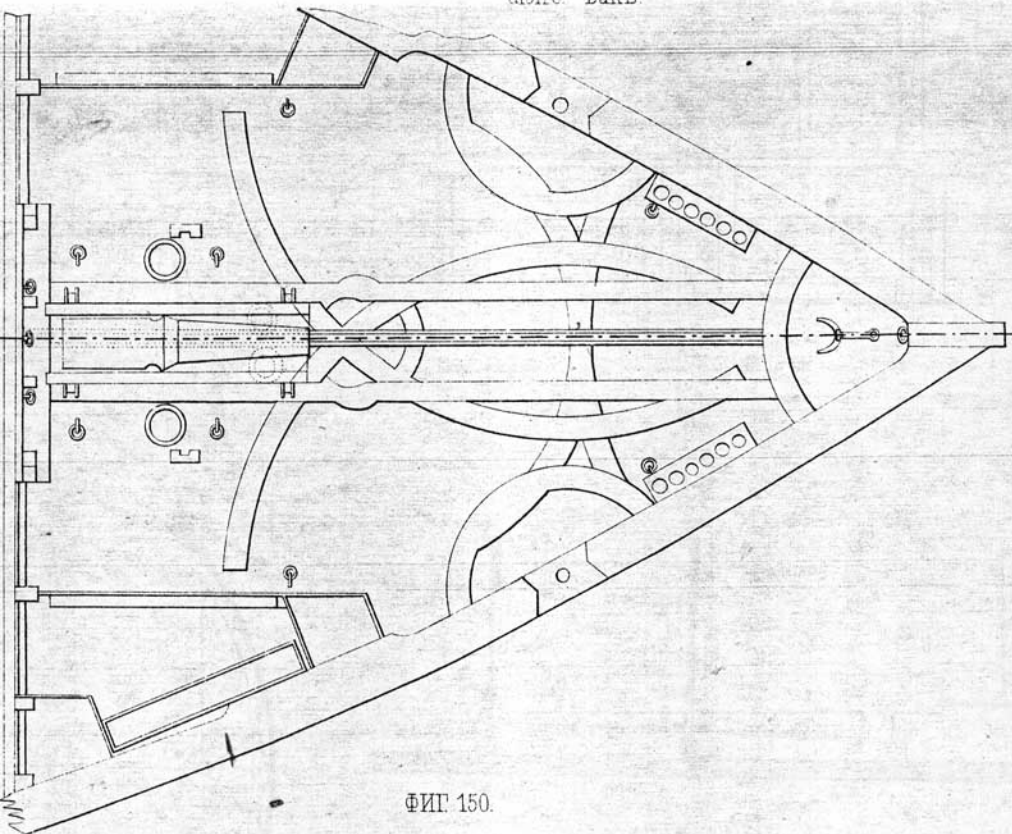

ФИГ. 150.

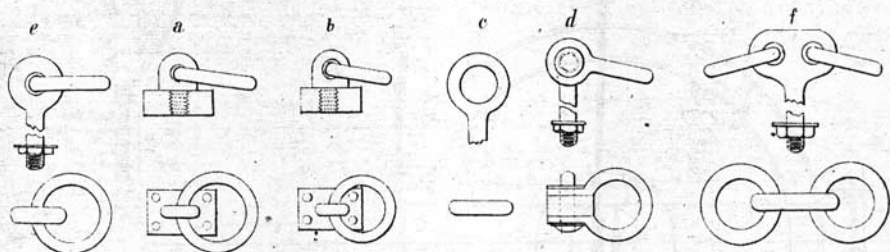

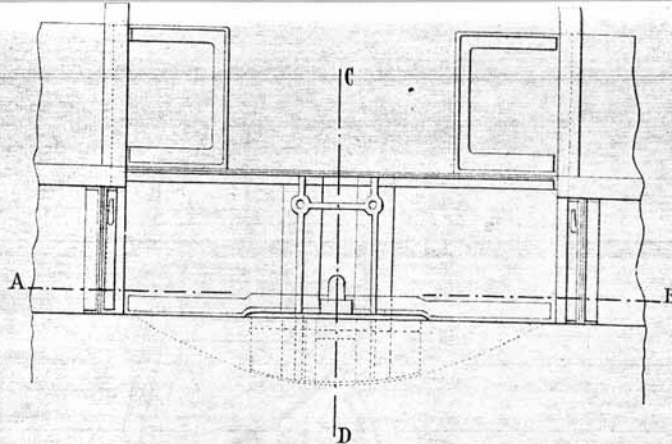
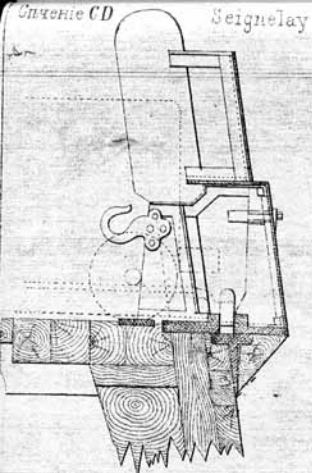

ФИГ 154.

ФИГ 148.

Сечение АВ.

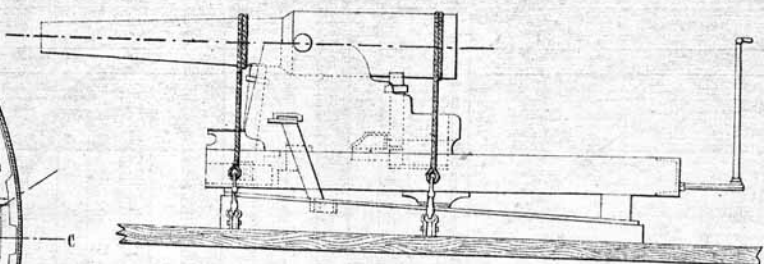
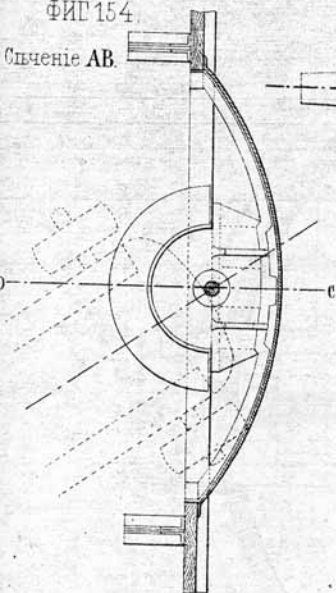

ФИГ 149.

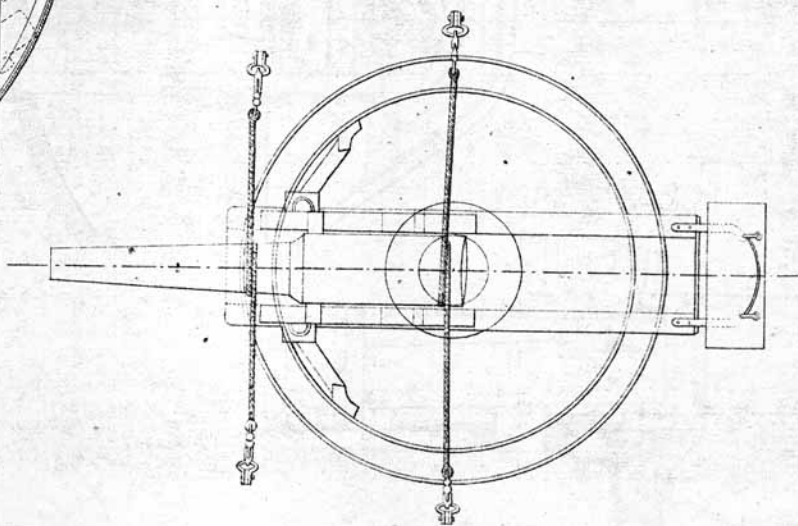



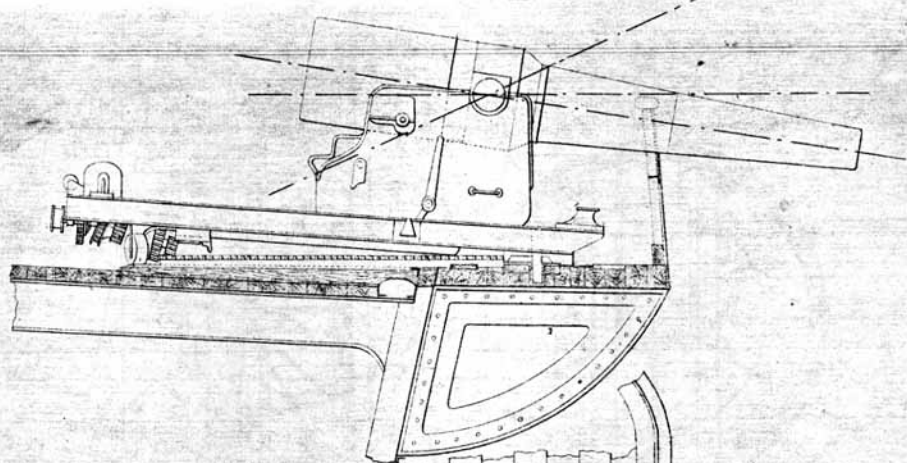

Фиг 156

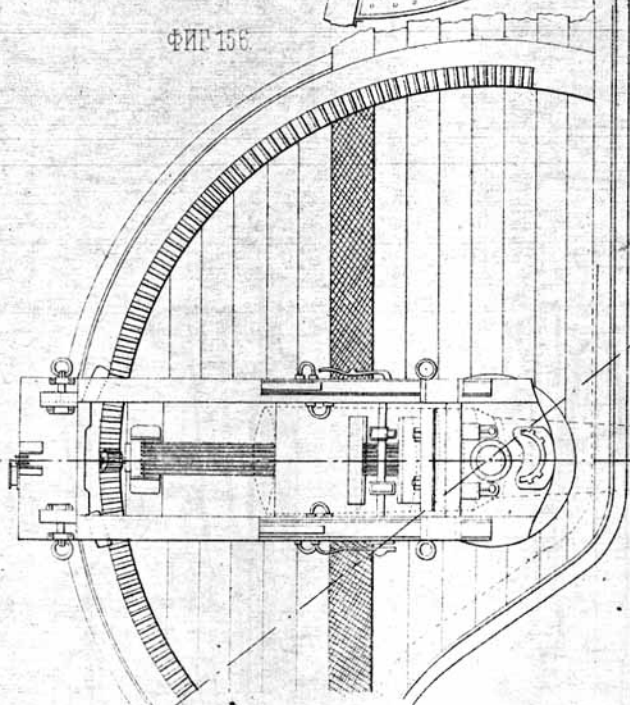

Фиг 161

Соедин.

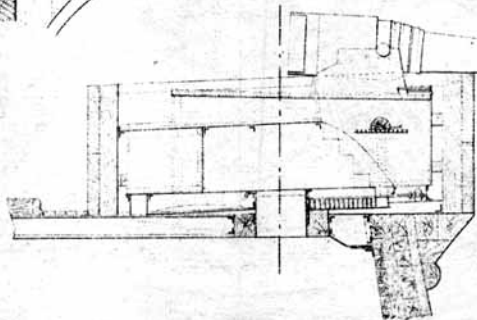

ФИГ 157

Eclaircur

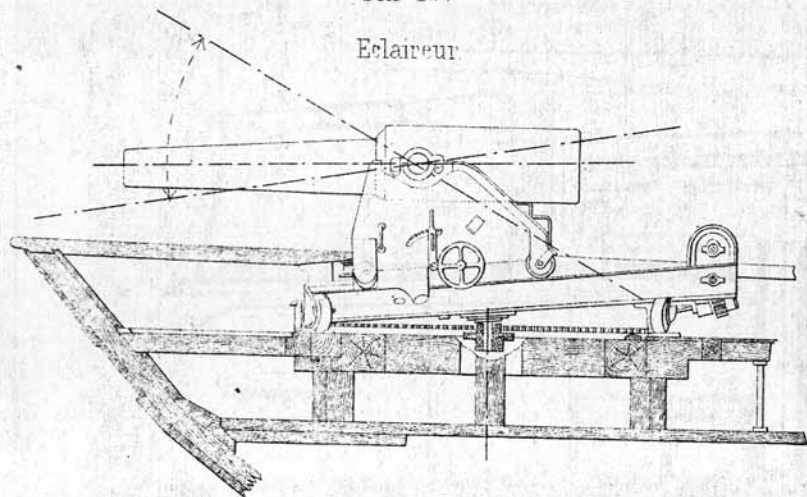

ФИГ 159

Decidée

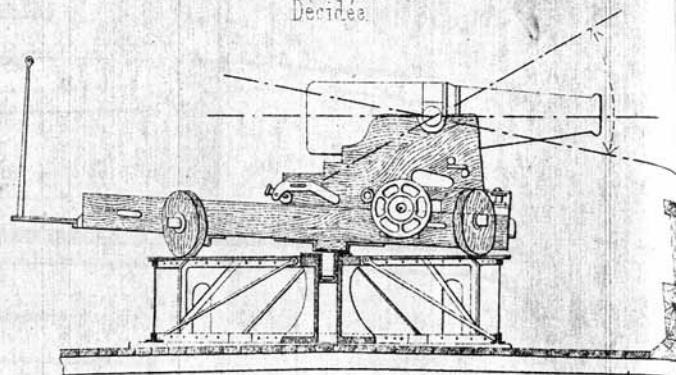

ФИГ 158

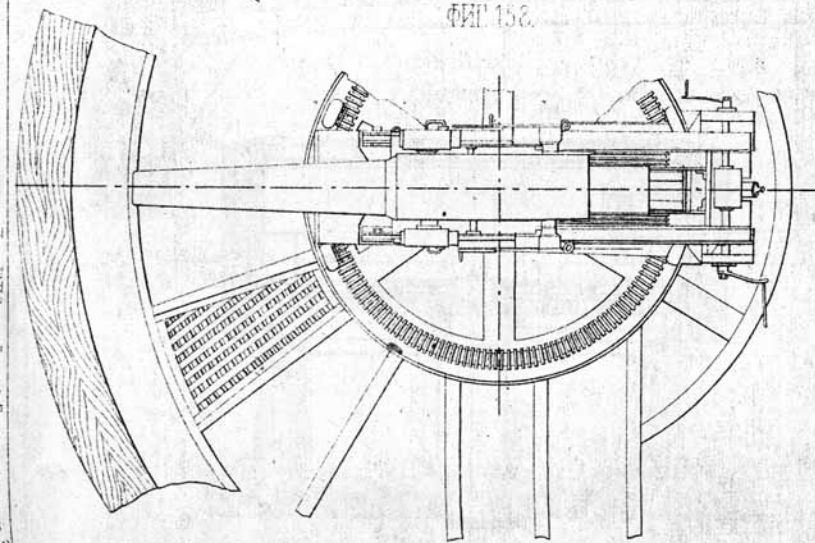

ФИГ 160

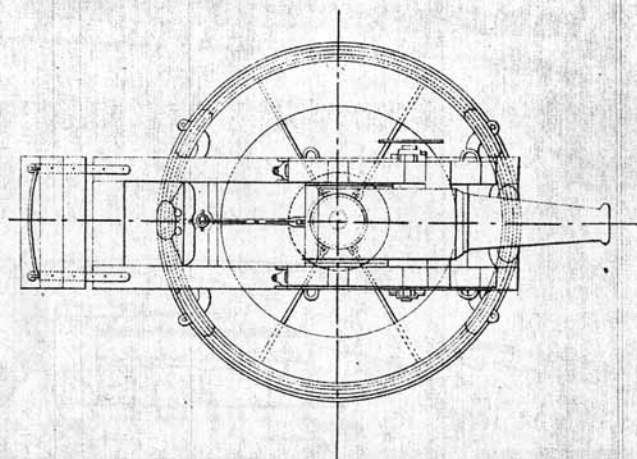

Bayard.

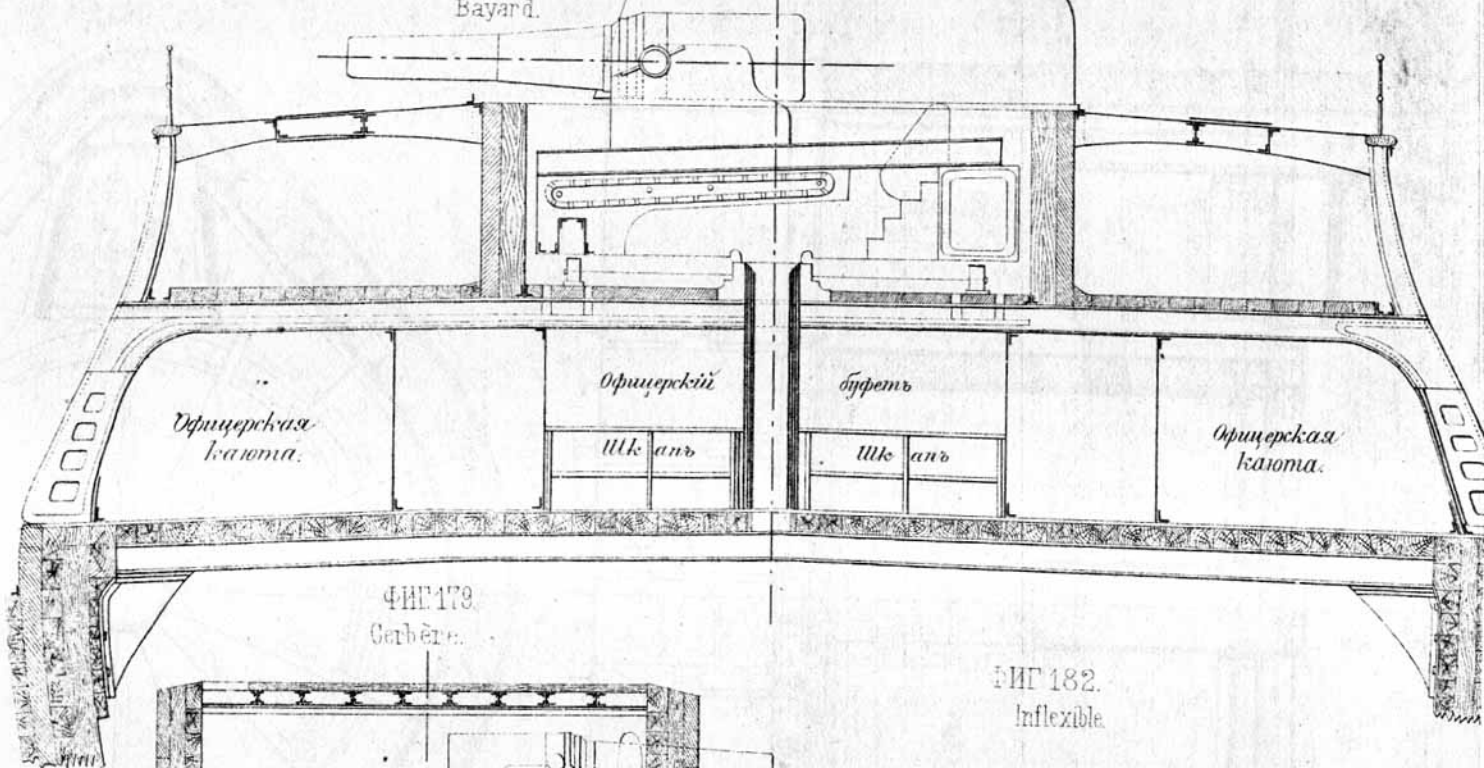

ФИГ 179.  
Сербьен.

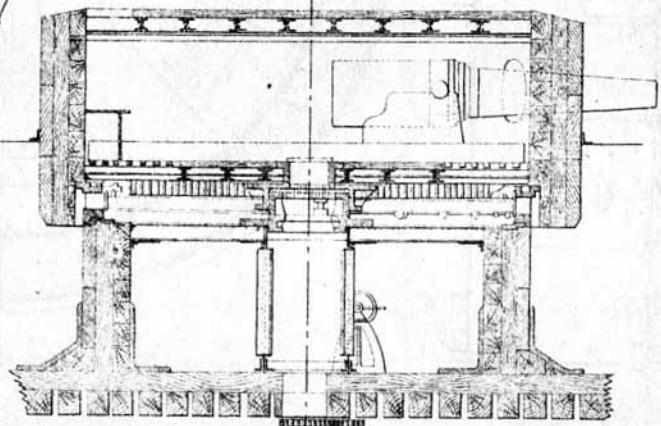

ФИГ 182.  
Inflexible

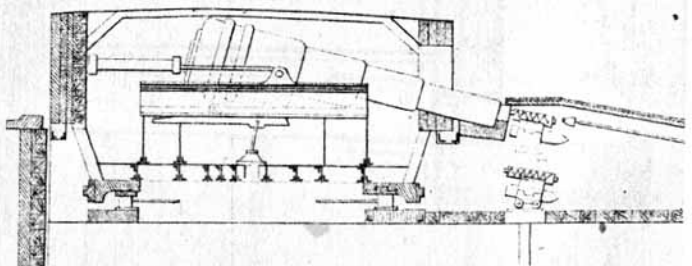

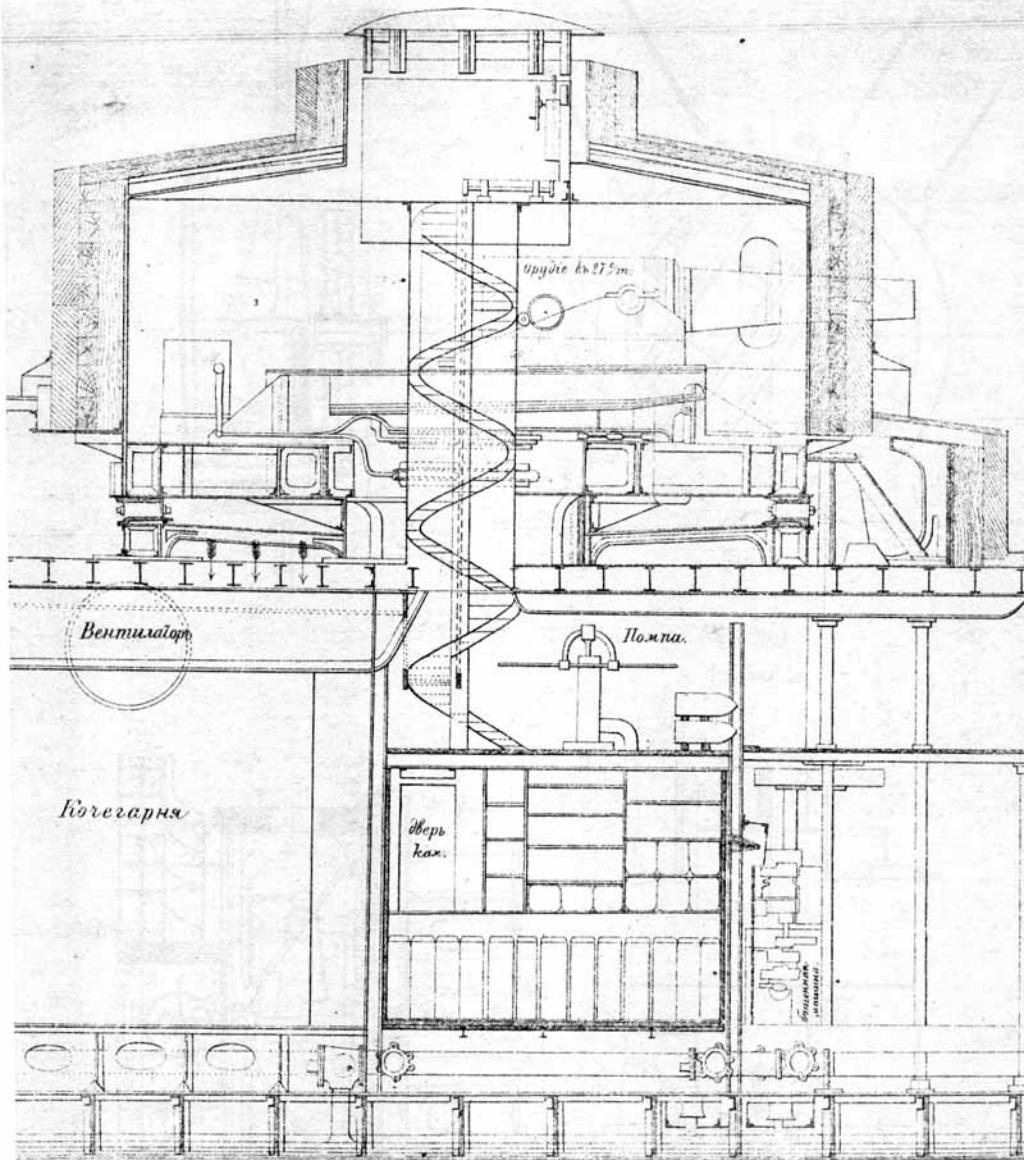

Устройство в 275 см.

Вентилятор

Помпа.

Бюбегарня

дверь  
ках.

Бюбегарня  
печи

ФИГ. 173.

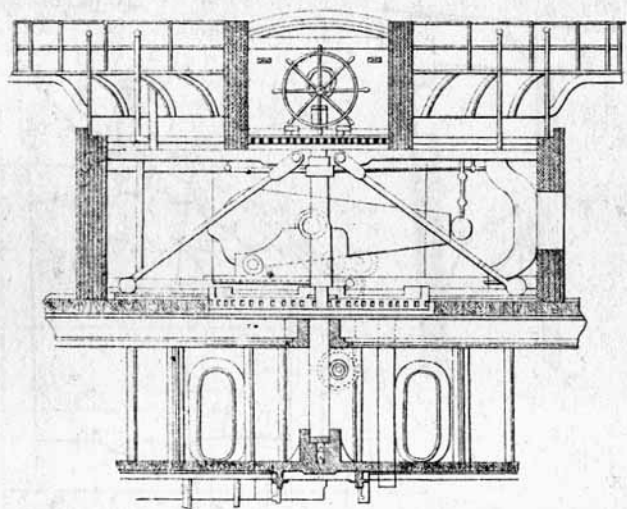

ФИГ. 180.  
Thunderer.

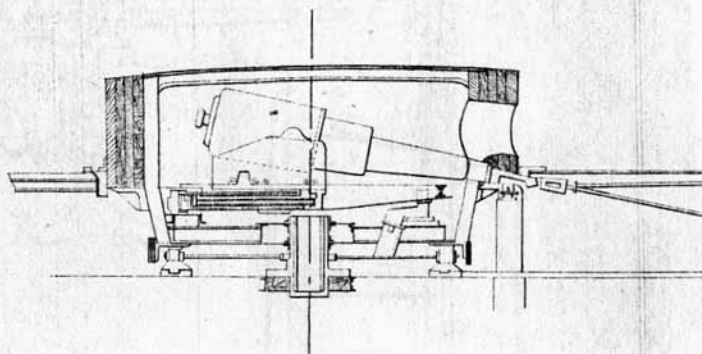

ФИГ. 181.

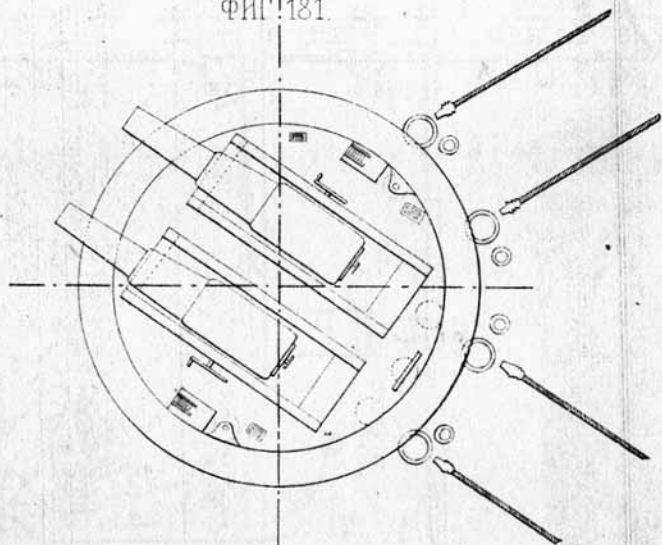

ФИГ. 189.  
Inflexible

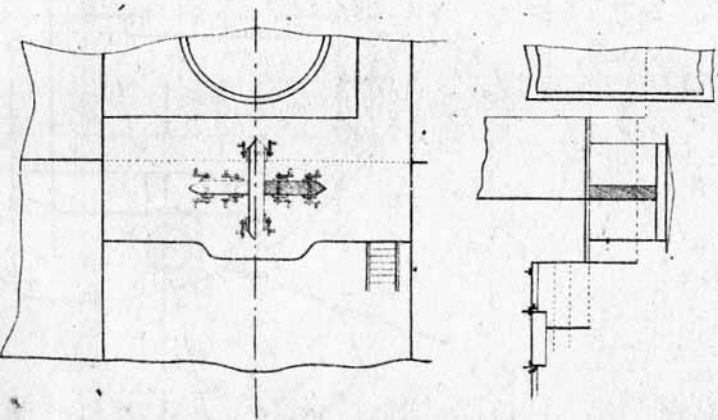



*Висота н.с.га.навіршка*

Фиг. 184

Dévastation

Фиг. 185

Фиг. 187

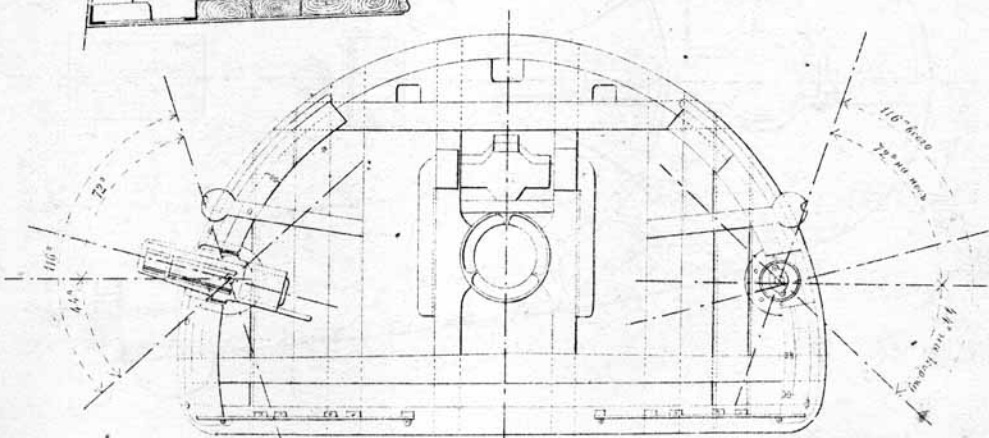



Deva-station

ФИГ. 196

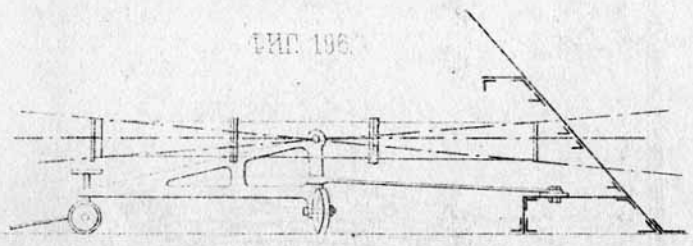

ФИГ. 197

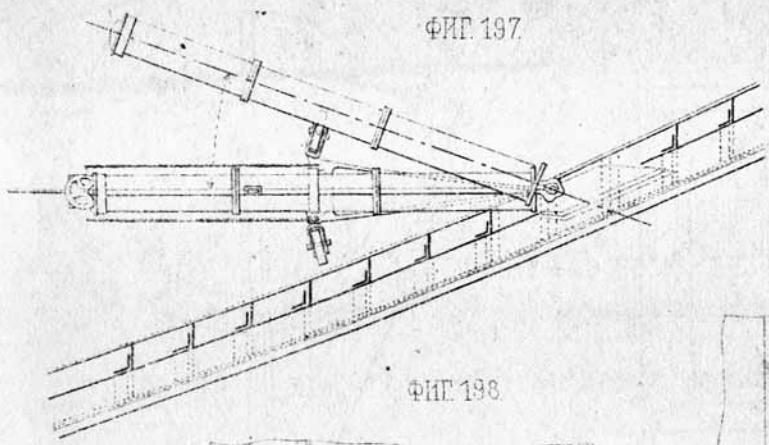

ФИГ. 198

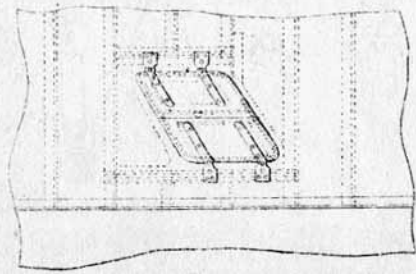

ФИГ. 199

Предельное сьчч.

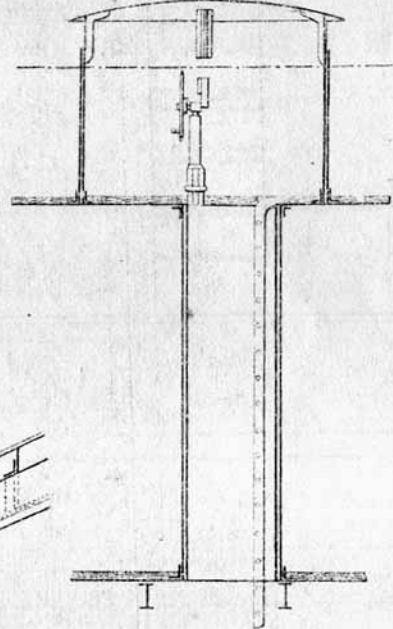

ФИГ. 191

Погереча сьчч.

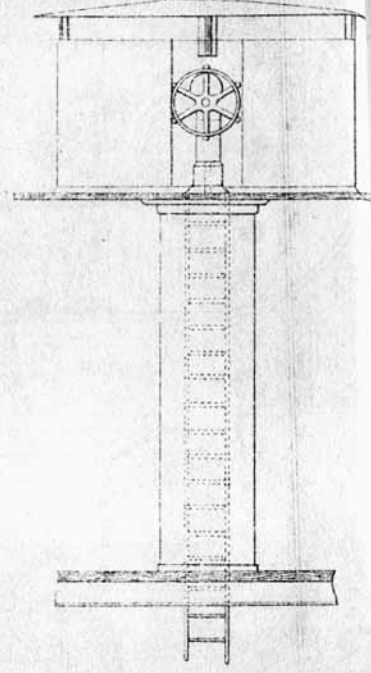

ФИГ. 193 Гориз. сьчч.

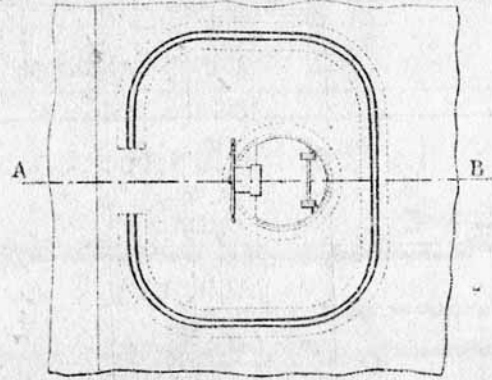

FIG. 199

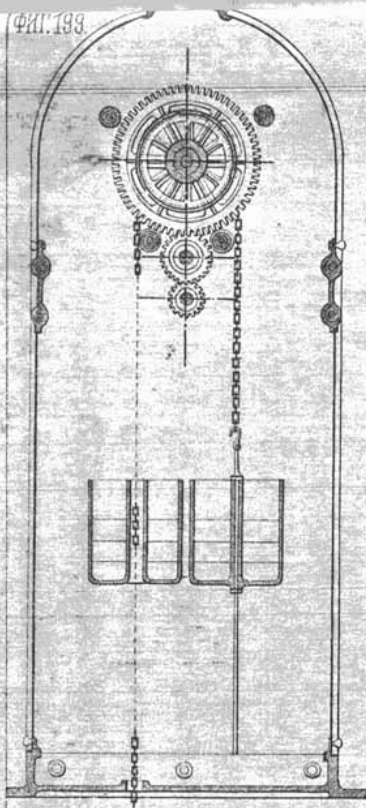

FIG. 200

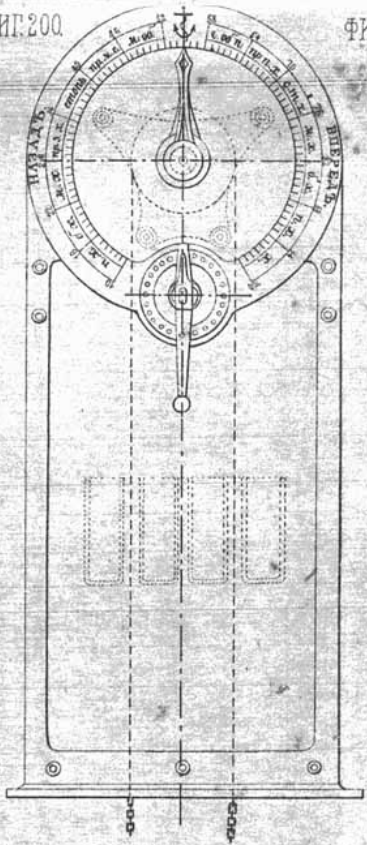

FIG. 201

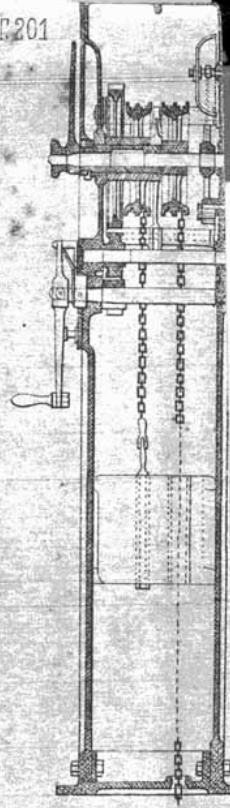
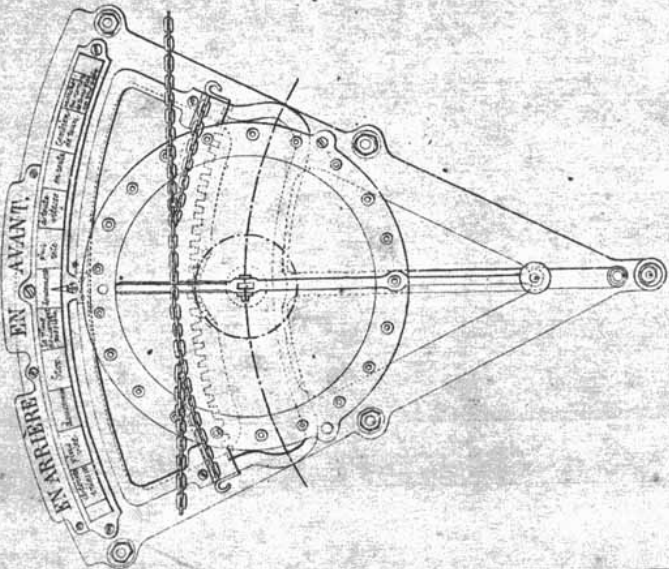
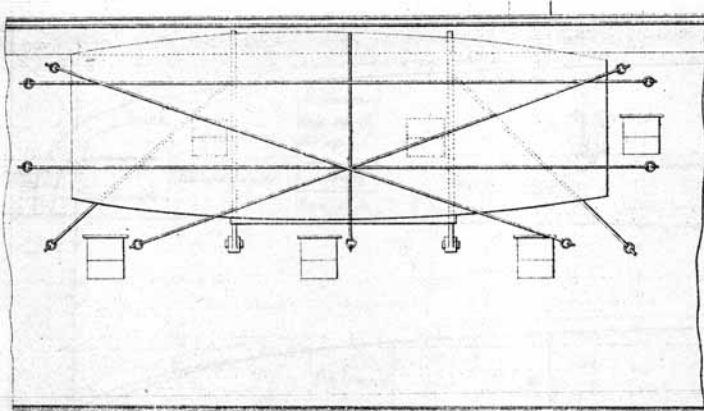
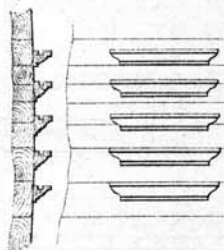

FIG. 202





Фиг. 16



Фиг. 18

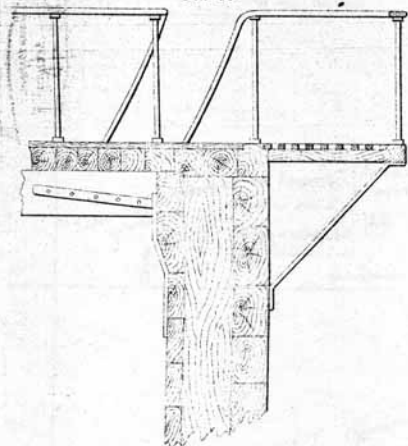

Фиг. 17

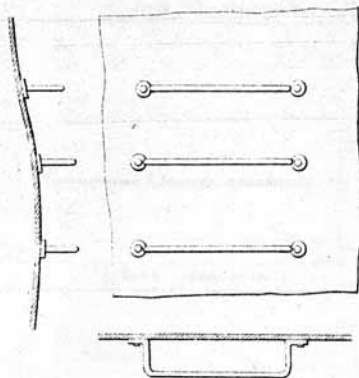

Фиг. 19

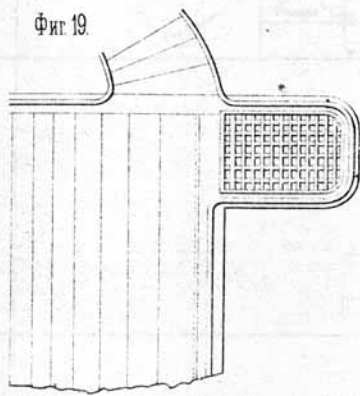

Фиг. 27

